

ABC

No Prep

Workbook

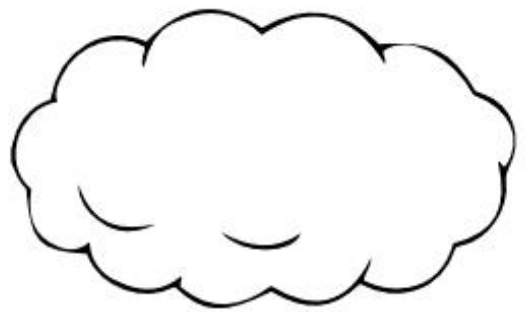

Thank you for downloading this free book!

For questions, corrections, or comments please email:

miniaturemasterminds@gmail.com



miniaturemasterminds.com

Name: _____

Write The Letter

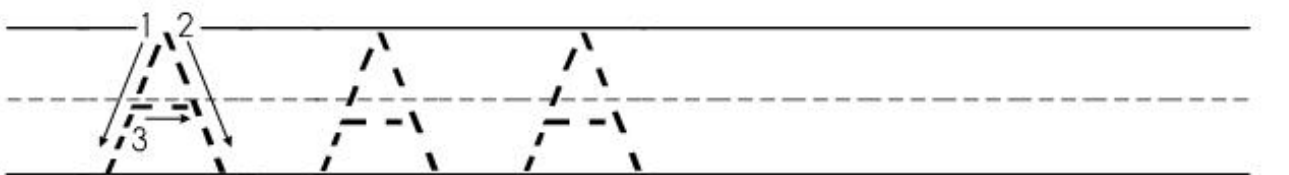
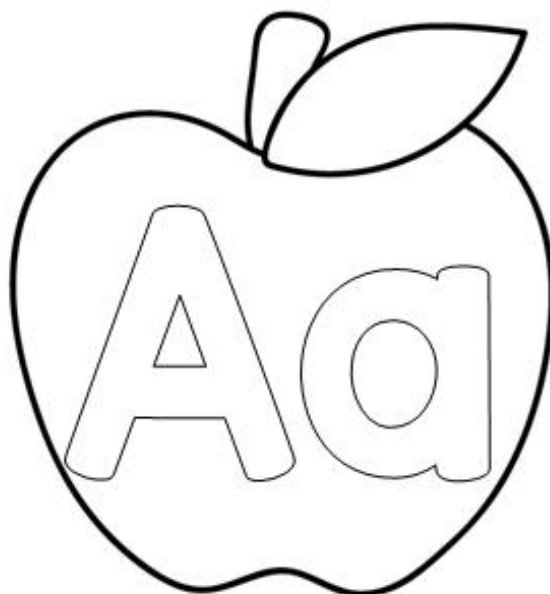
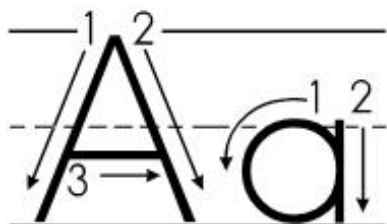

Name: _____

Write The Letter

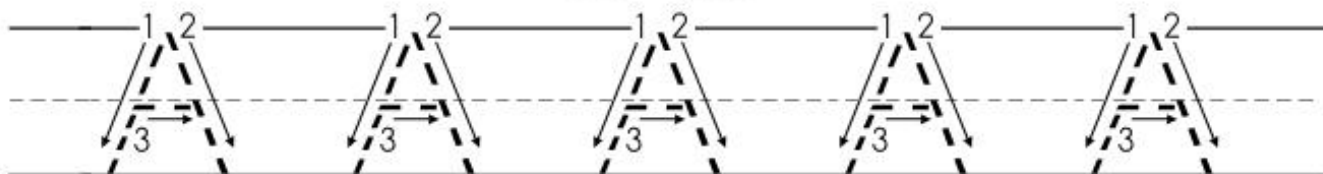
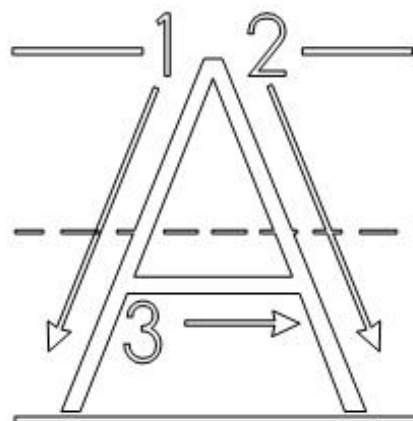
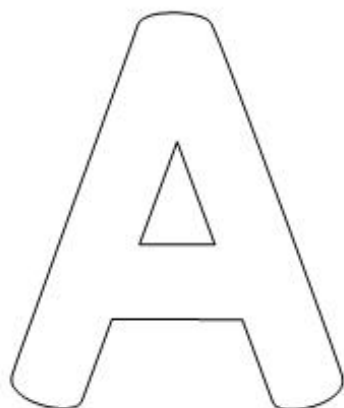

Name: _____

Find and Color

Color the pictures that begin with the letter A

Aa

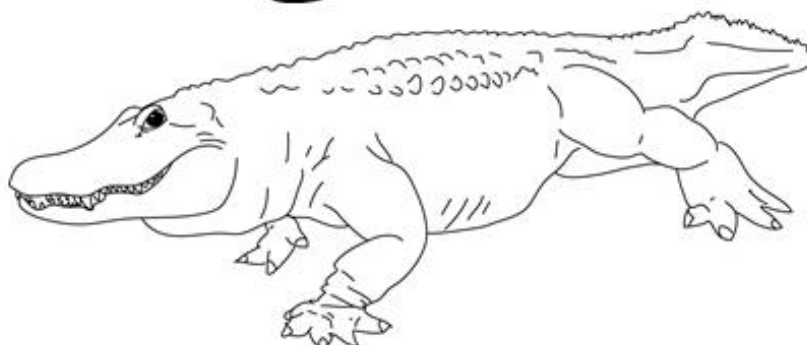
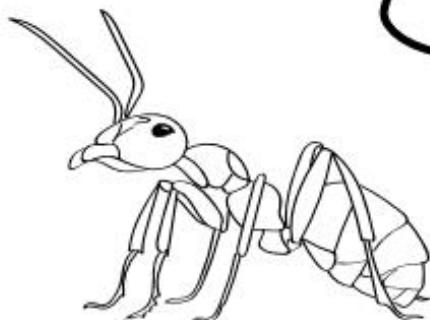
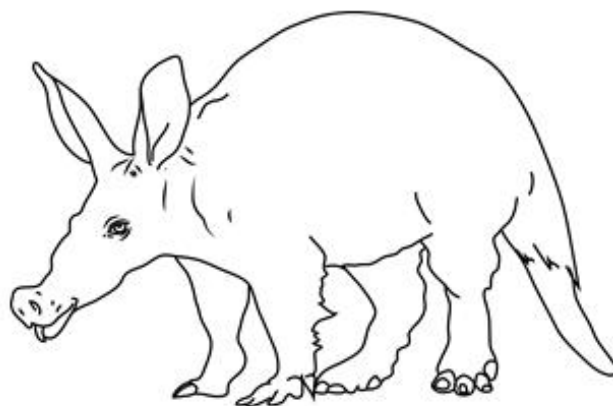

Name: -----

Letter Puzzles

Build the Upper and
Lower Case Puzzles

Aa

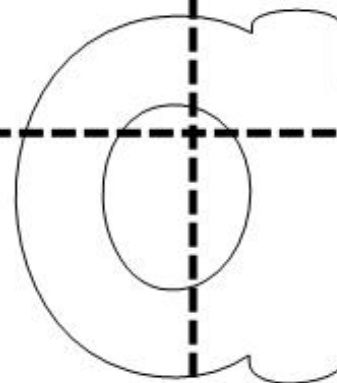
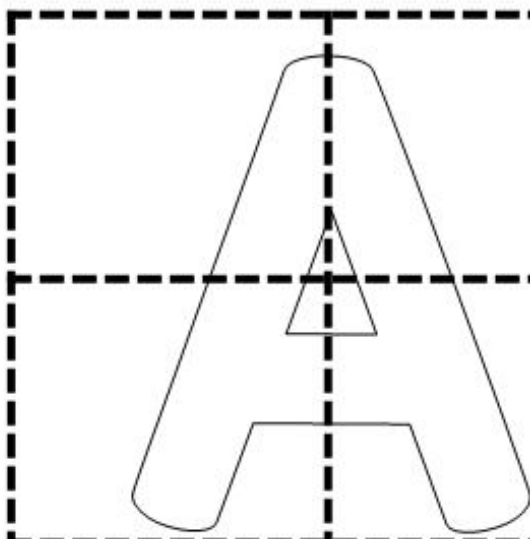

Name: _____

Letter Sorting

Sort the upper and lower case letters.

Aa

Upper

Lower

A

a

A

a

A

A

a

a

Name: _____

Graph The Letter

Count the letters and fill in the charts.

Aa

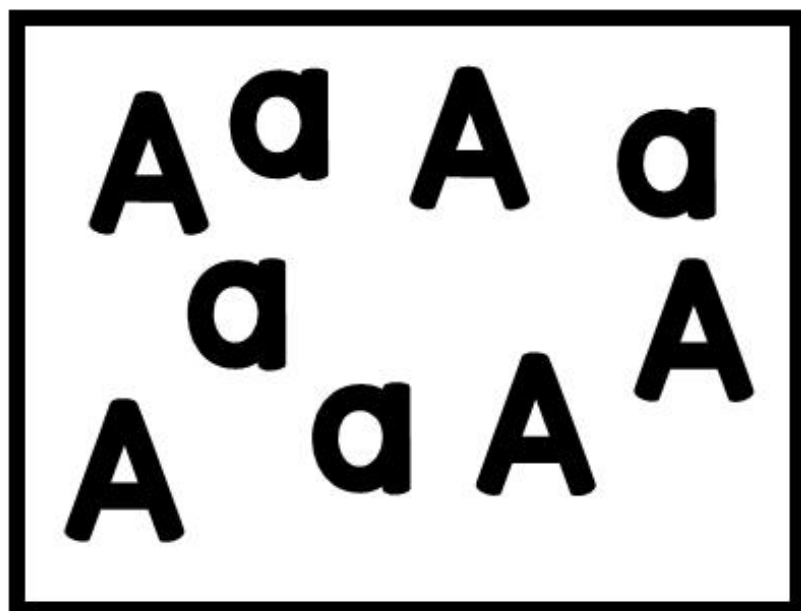

Tally Marks

A	
a	

Color the letter there are more of.

Aa

A

a

1	2	3	4	5
1	2	3	4	5

Name: _____

Write The Letter

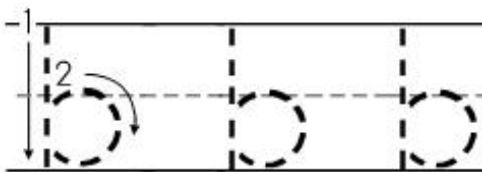
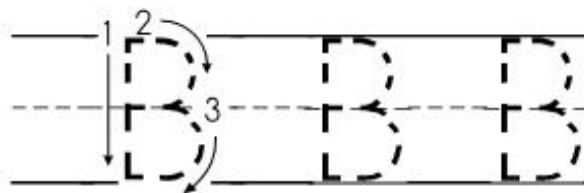
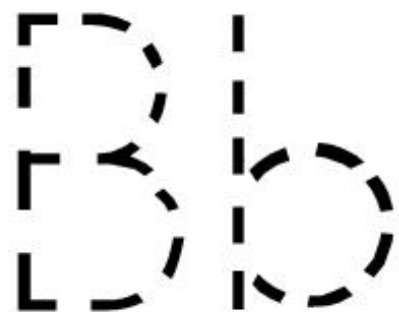
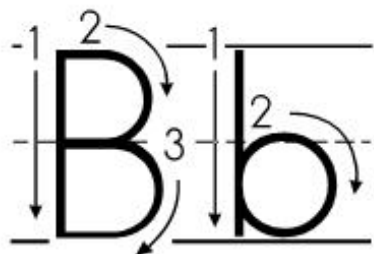

Name: _____

Write The Letter

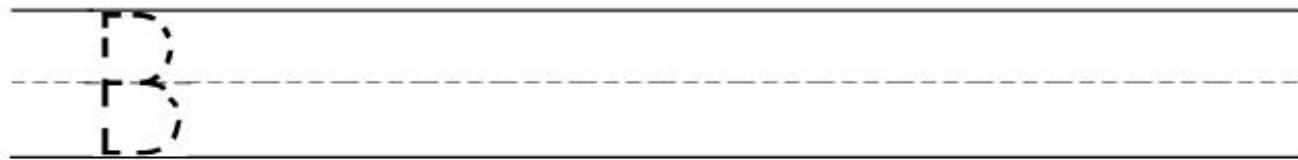
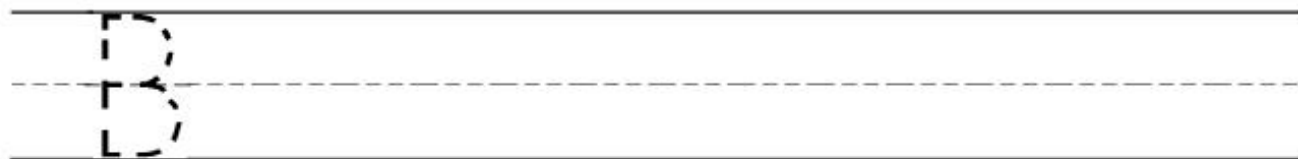
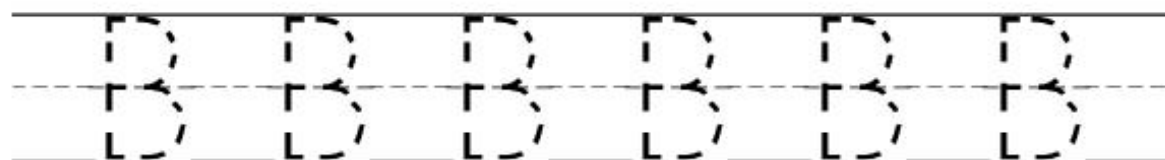
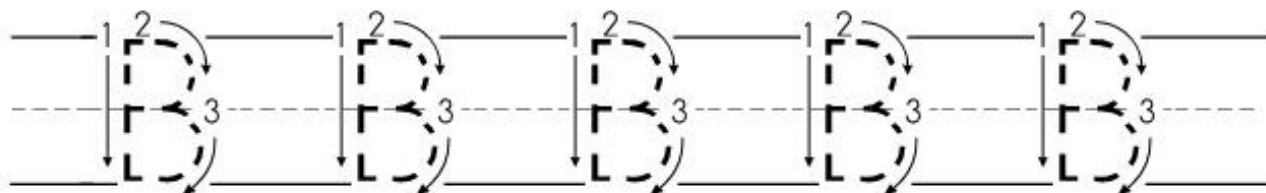
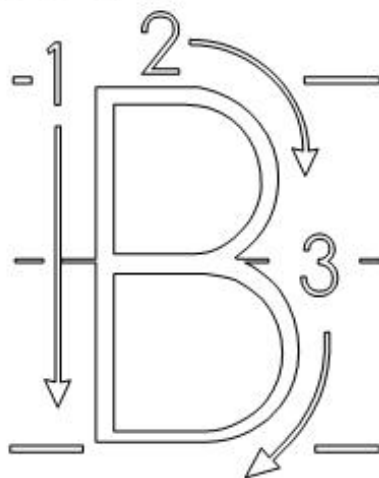

Name: _____

Find and Color

Color the pictures that begin with the letter B

Bb

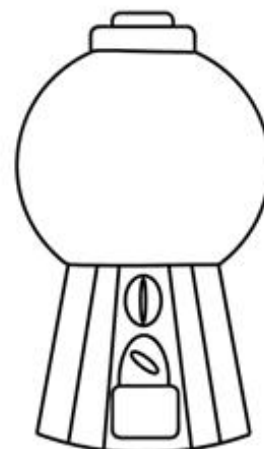
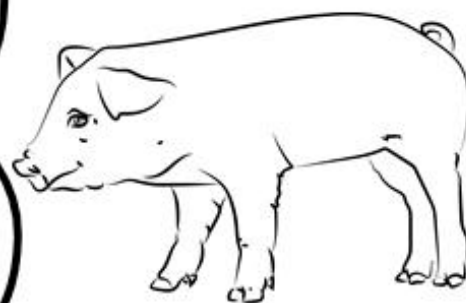
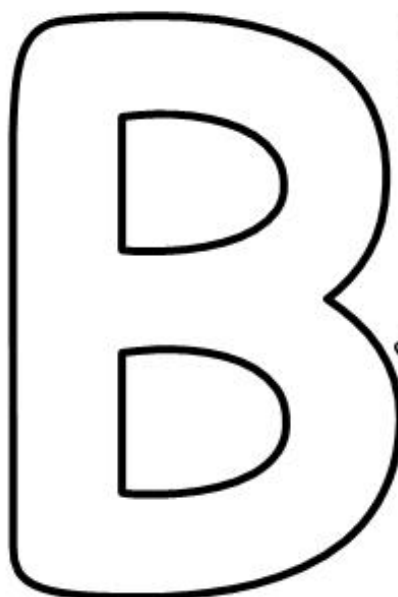
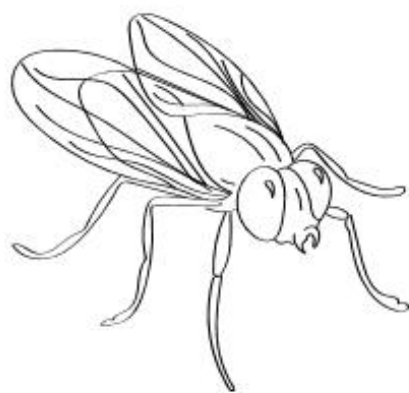

Name: -----

Letter Puzzles

Build the Upper and
Lower Case Puzzles

Bb

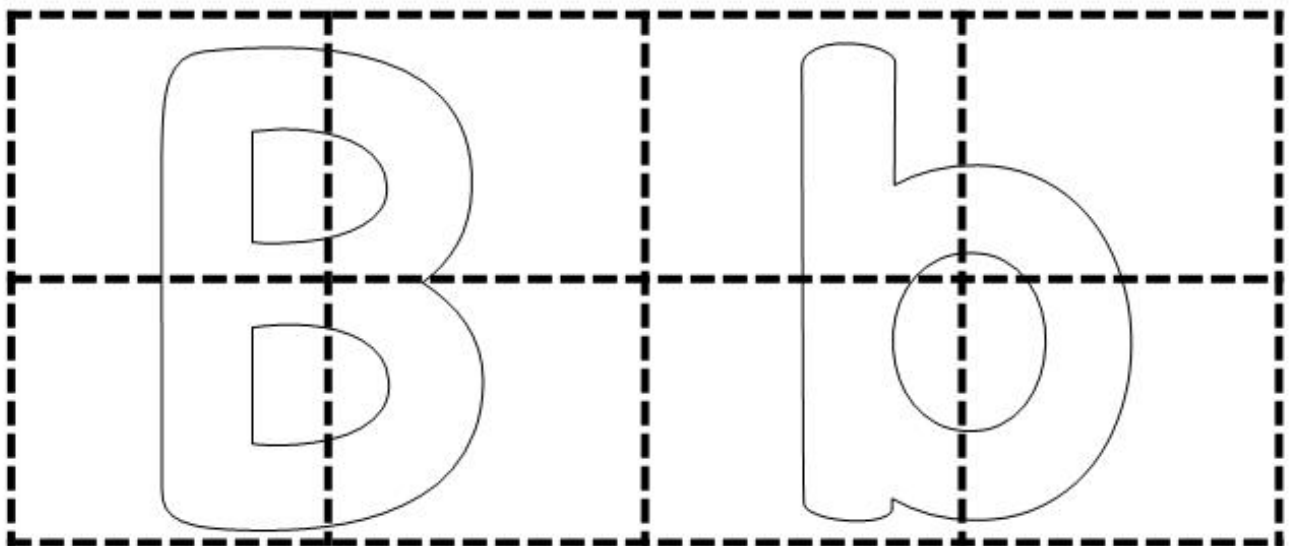

Name: _____

Letter Sorting

Sort the upper and lower case letters.

Bb

Upper

Lower

B

b

b

b

b

B

b

b

Name: _____

Graph The Letter

Count the letters and
fill in the charts.

Bb

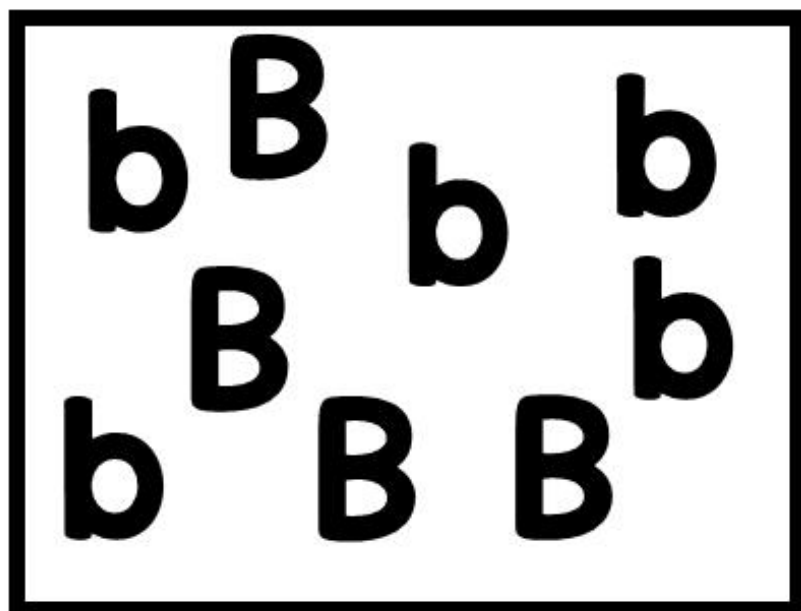

Tally Marks

Bb

Color the
letter there
are more of.

Bb

Bb

1	2	3	4	5
1	2	3	4	5

Name: _____

Write The Letter

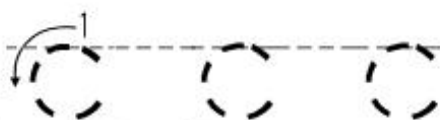
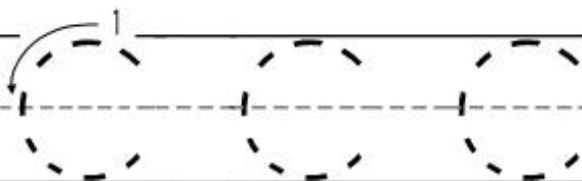
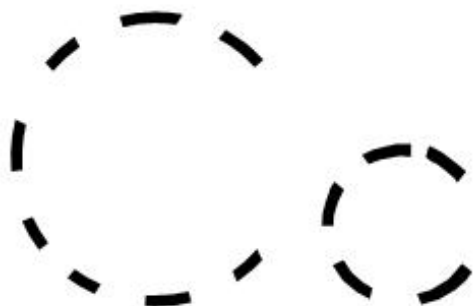
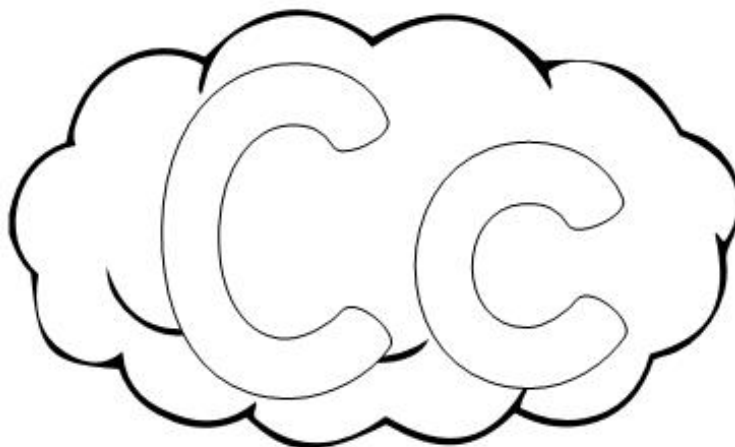
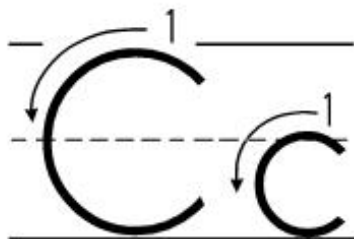

Name: _____

Write The Letter

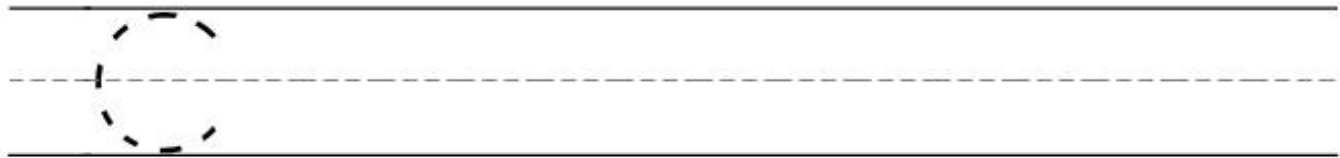
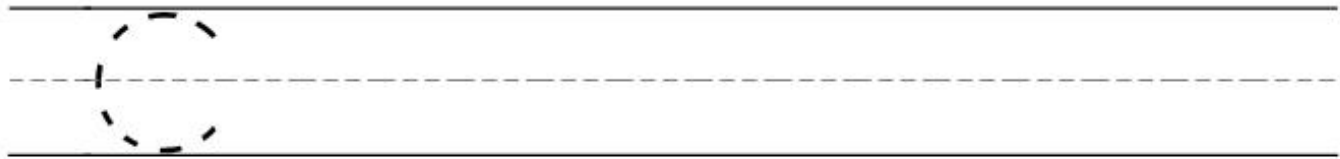
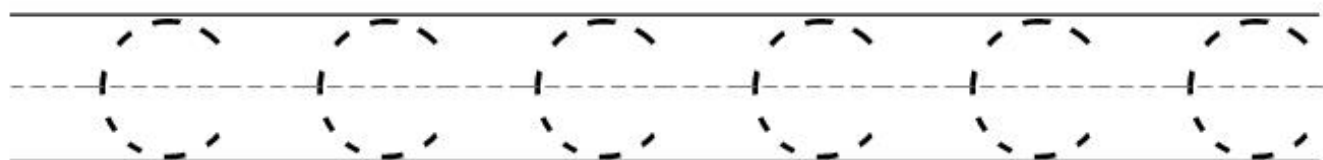
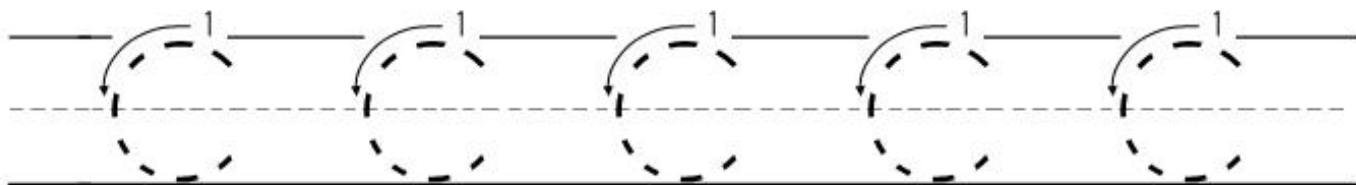
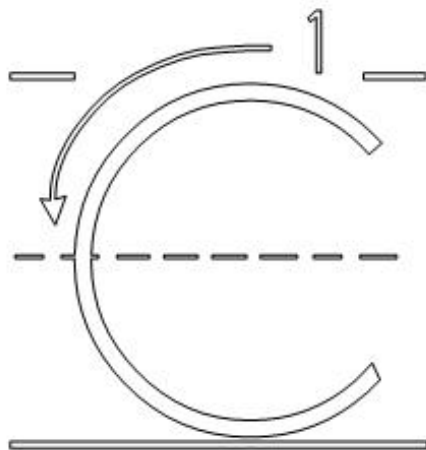
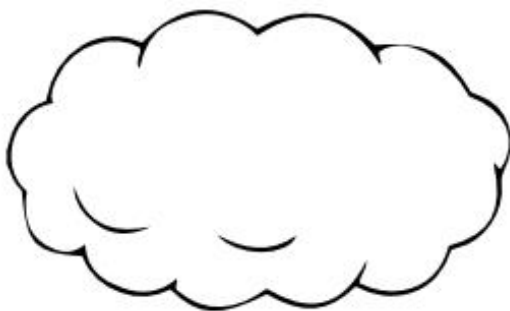
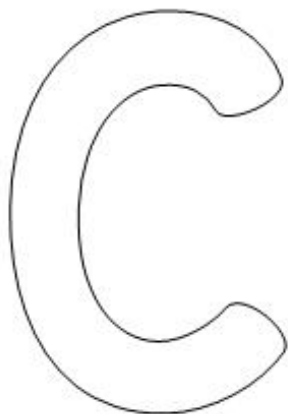

Name: _____

Find and Color

Color the pictures that begin with the letter C

Cc

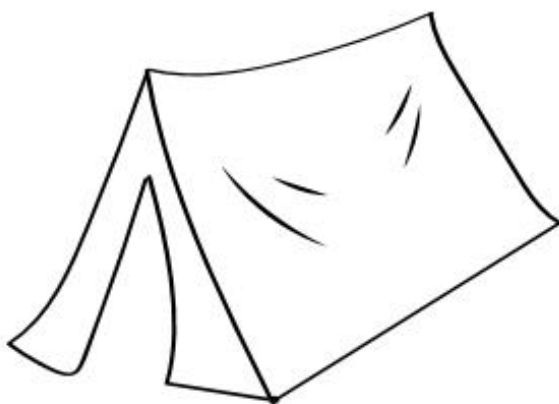

Name: -----

Letter Puzzles

Build the Upper and
Lower Case Puzzles

Cc

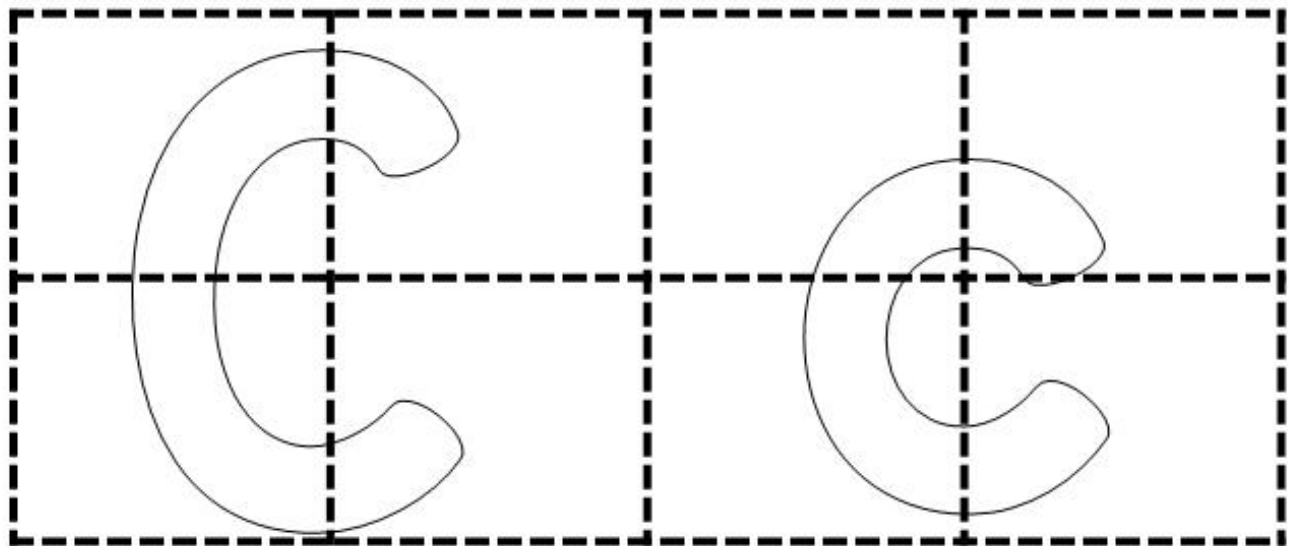

Name: _____

Letter Sorting

Sort the upper and lower case letters.

Cc

Upper

Lower

C

c

C

C

C

C

C

C

Name: _____

Graph The Letter

Count the letters and
fill in the charts.

Cc

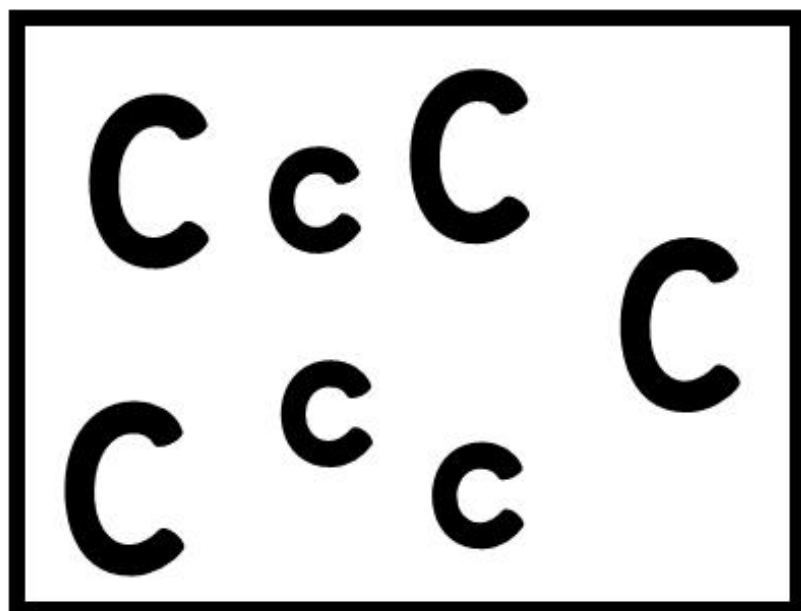

Tally Marks

Color the
letter there
are more of.

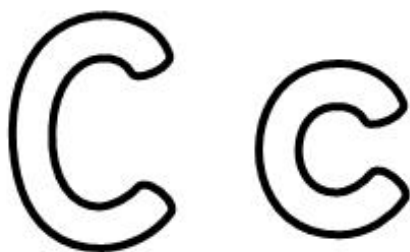

1	2	3	4	5
1	2	3	4	5

Name: _____

Write The Letter

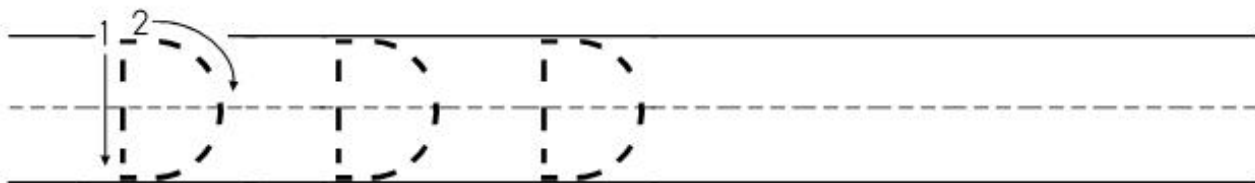
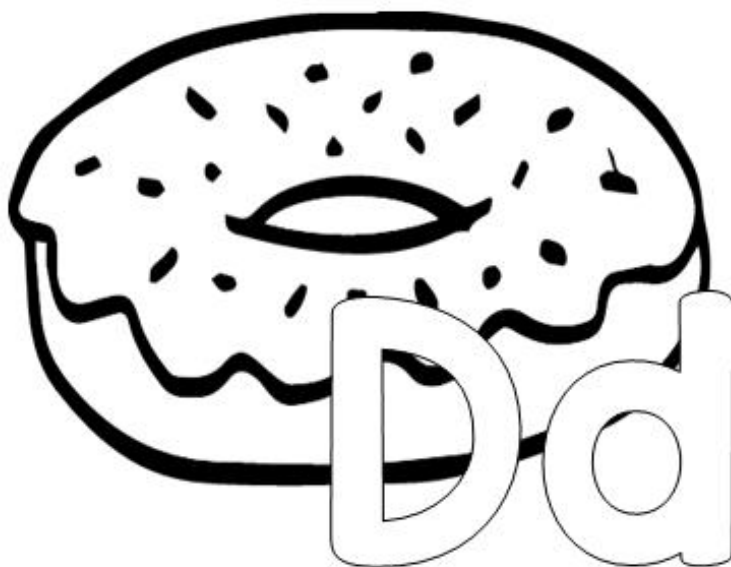
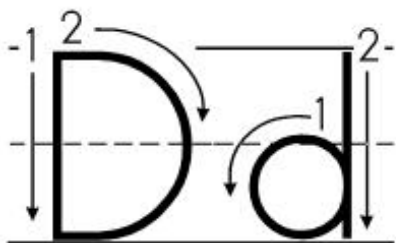

Name: _____

Write The Letter

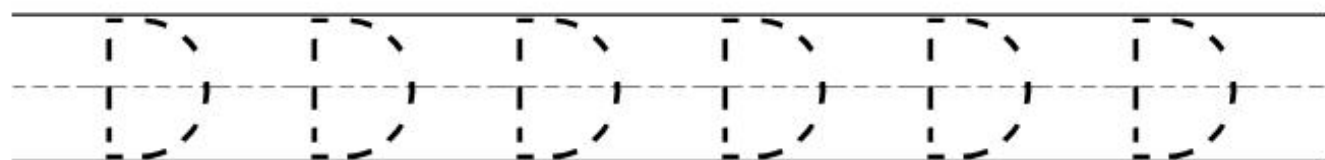
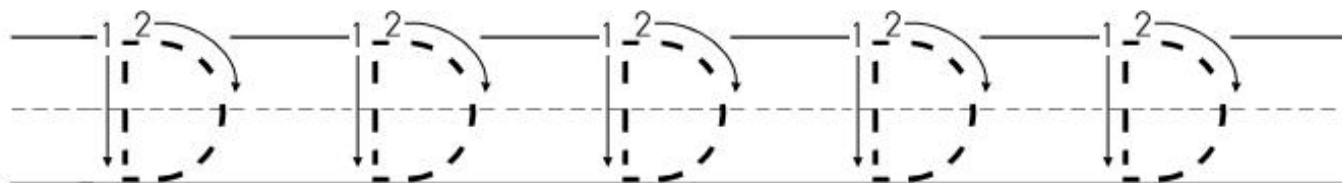
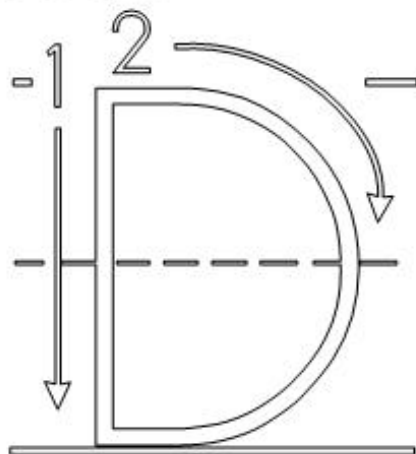
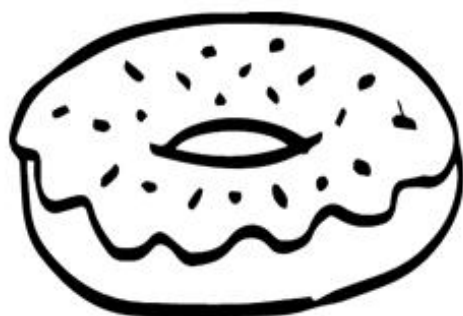
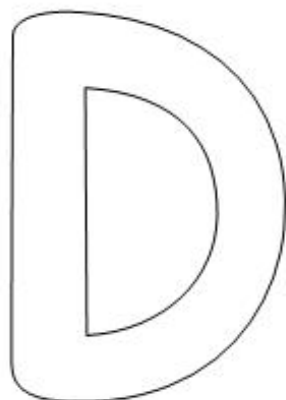

Name: _____

Find and Color

Color the pictures that begin with the letter D

Dd

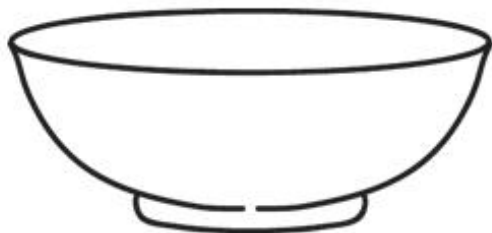
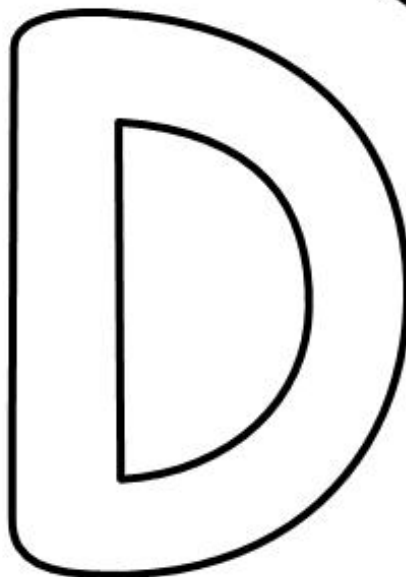
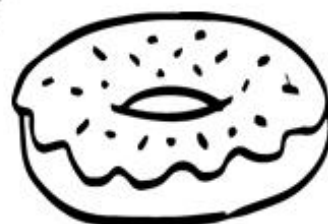
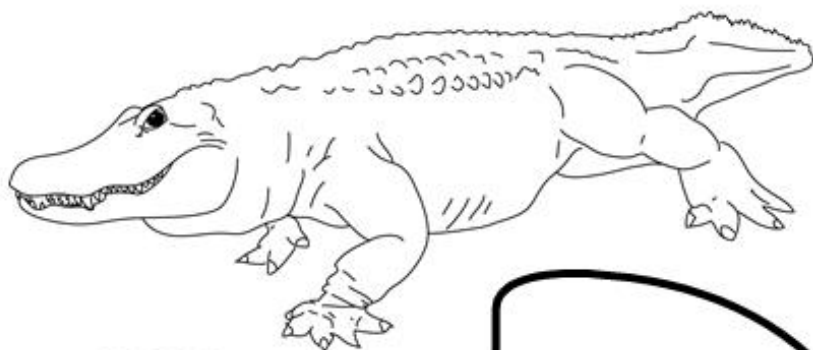

Name: -----

Letter Puzzles

Build the Upper and
Lower Case Puzzles

Dd

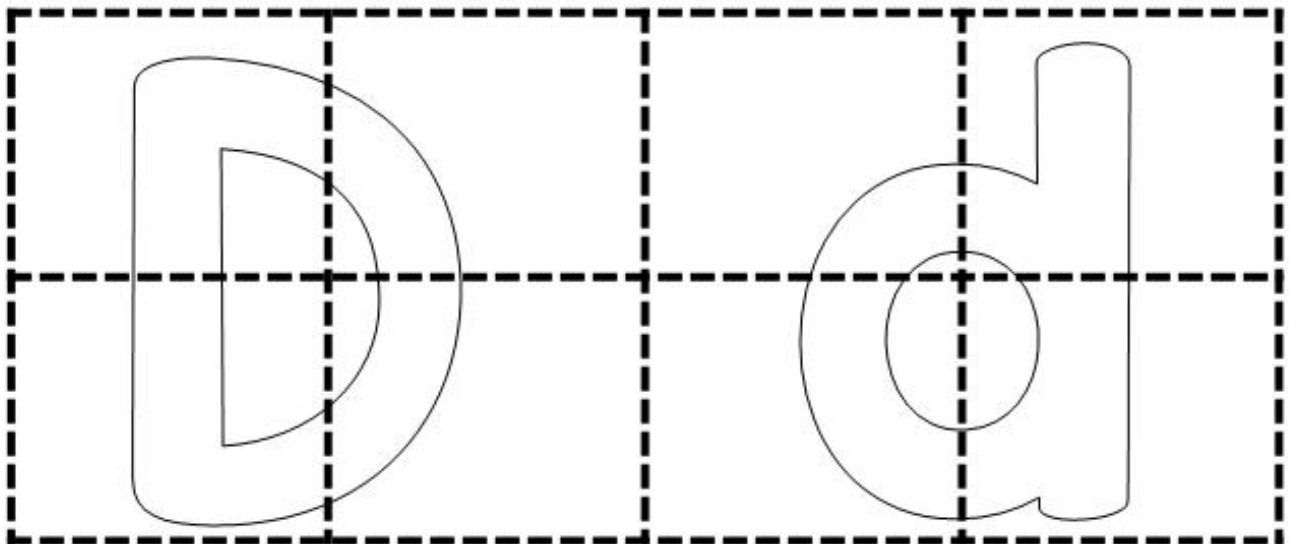

Name: _____

Letter Sorting

Sort the upper and lower case letters.

Dd

Upper

Lower

d

D

d

D

D

D

d

d

Name: _____

Graph The Letter

Count the letters and
fill in the charts.

Dd

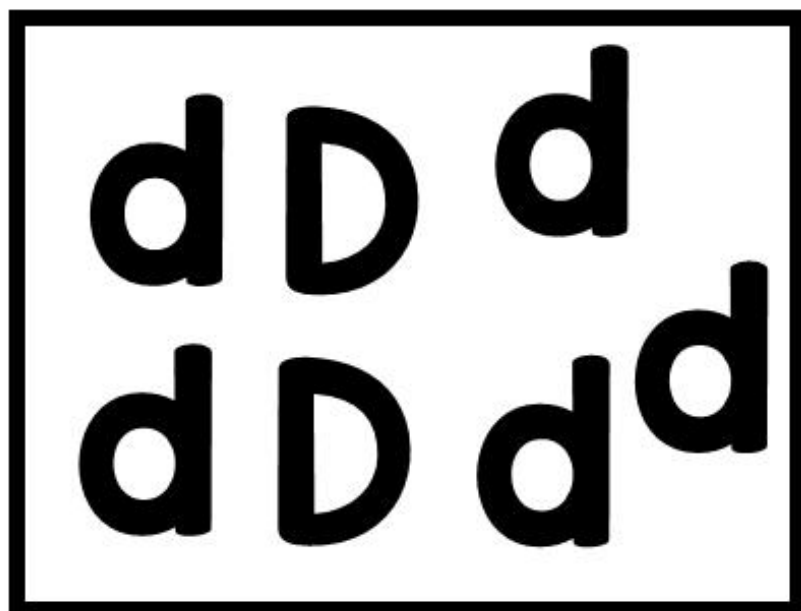

Tally Marks

D
d

Color the
letter there
are more of.

D d

D d

1	2	3	4	5
1	2	3	4	5

Name: _____

Write The Letter

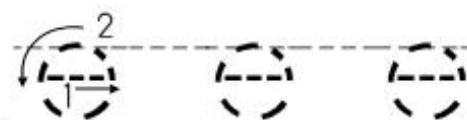
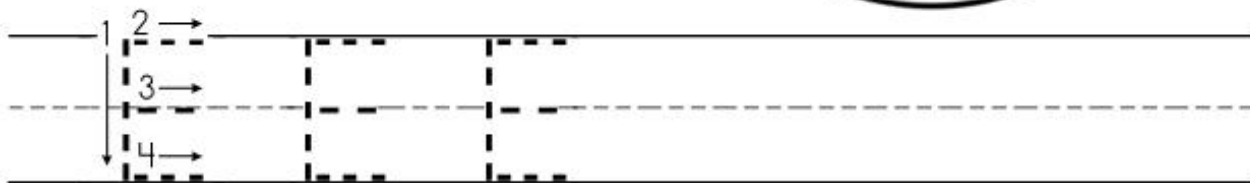
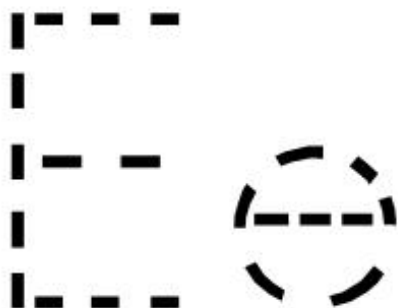
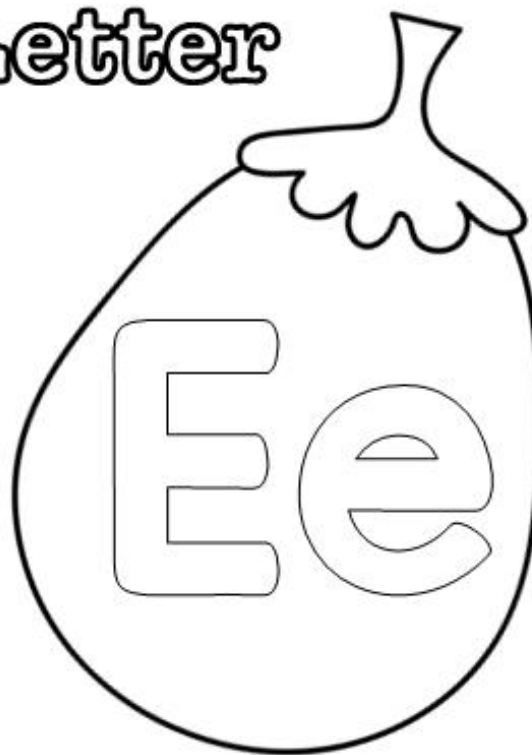
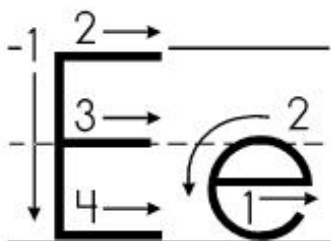

Name: _____

Write The Letter

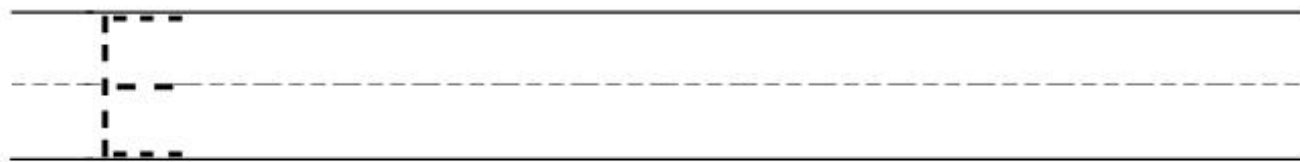
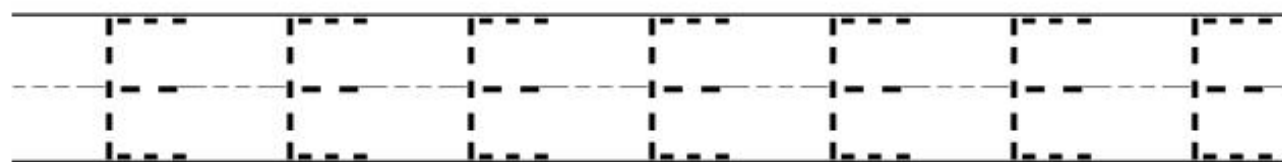
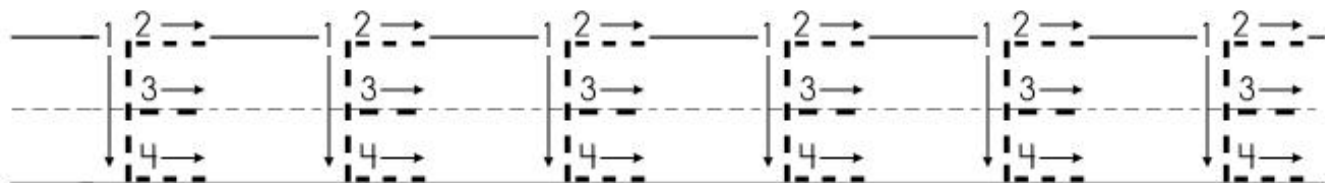
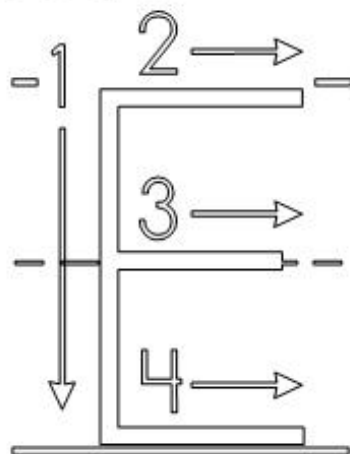

Name: _____

Find and Color

Color the pictures that begin with the letter E

Ee

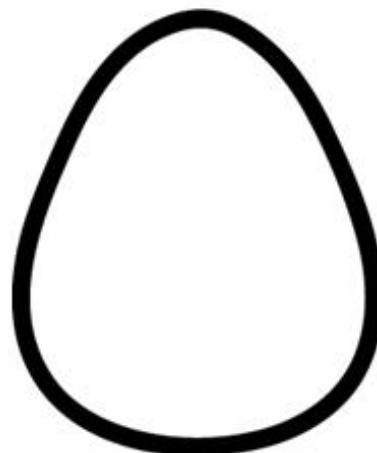
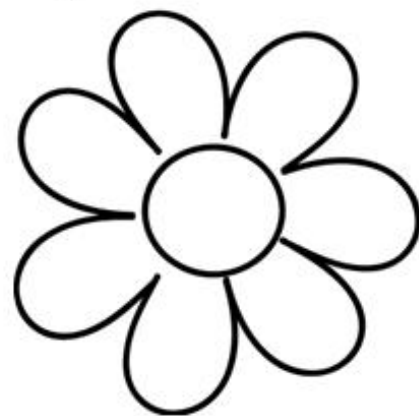
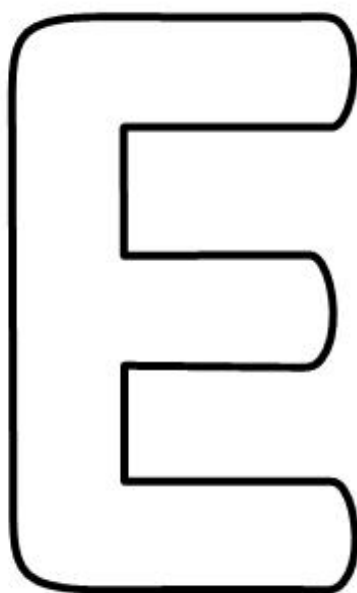

Name: -----

Letter Puzzles

Build the Upper and
Lower Case Puzzles

Ee

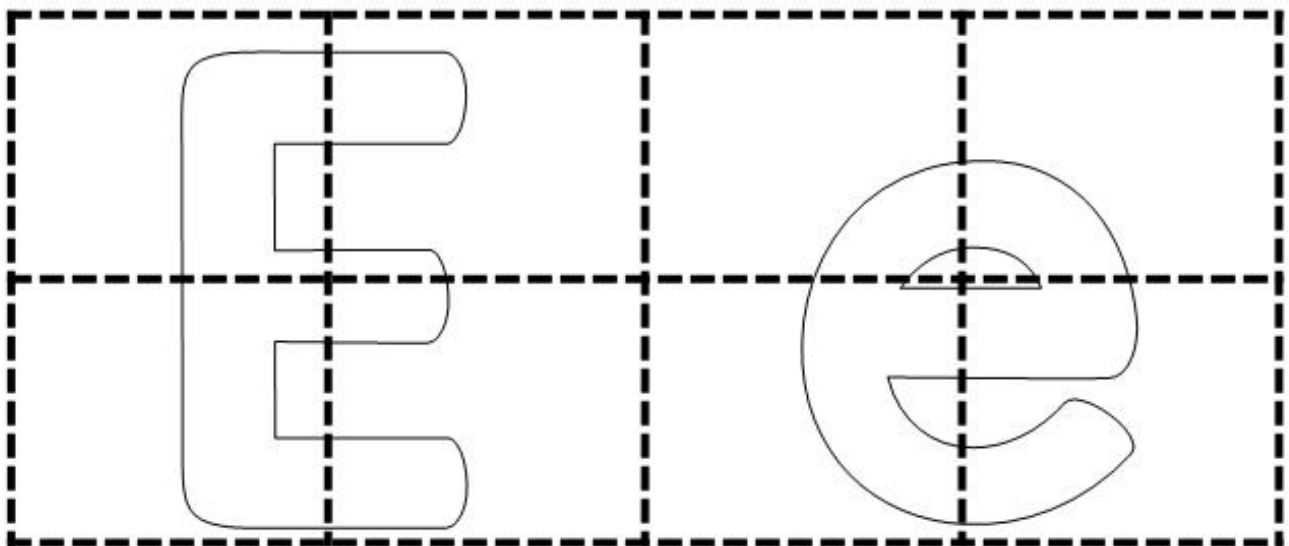

Name: _____

Letter Sorting

Sort the upper and lower case letters.

Ee

Upper

Lower

E

e

E

E

e

E

e

e

Name: _____

Graph The Letter

Count the letters and
fill in the charts.

Ee

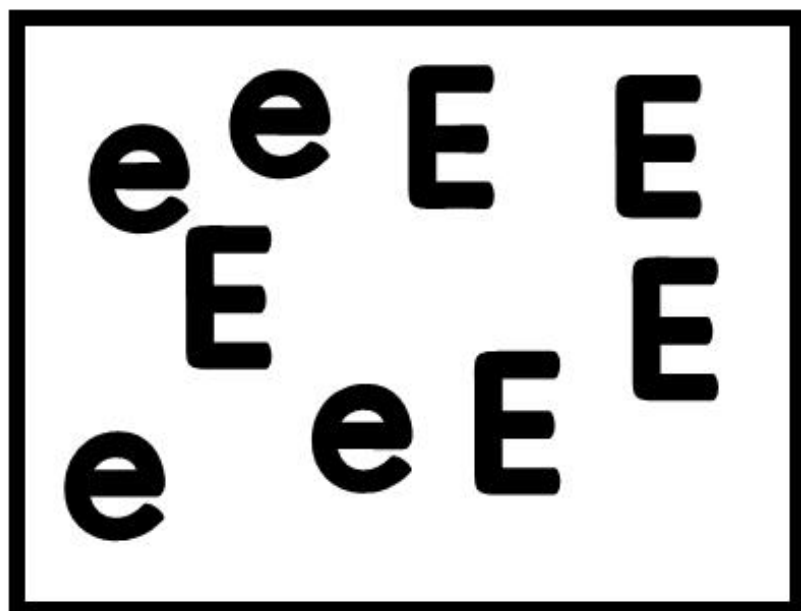

Tally Marks

Color the
letter there
are more of.



E

e

1	2	3	4	5
1	2	3	4	5

Name: _____

Write The Letter

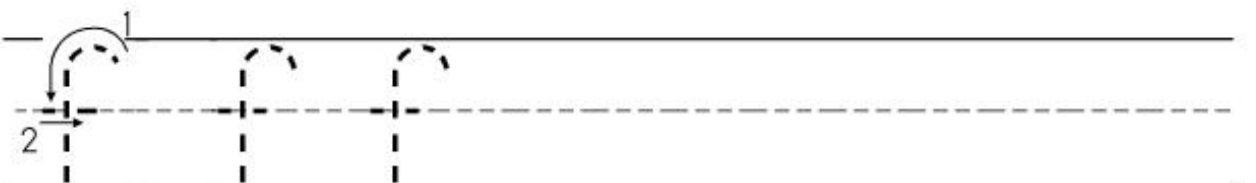
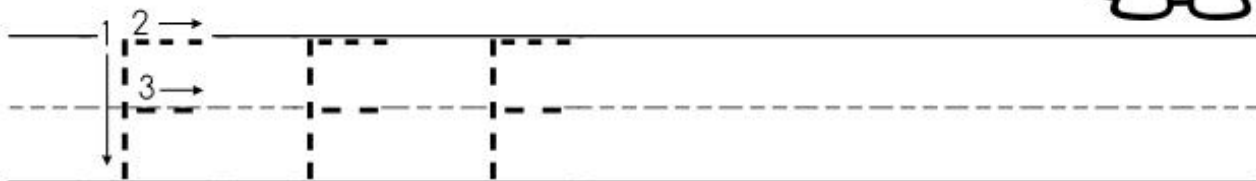
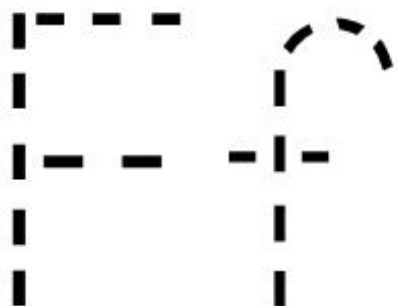
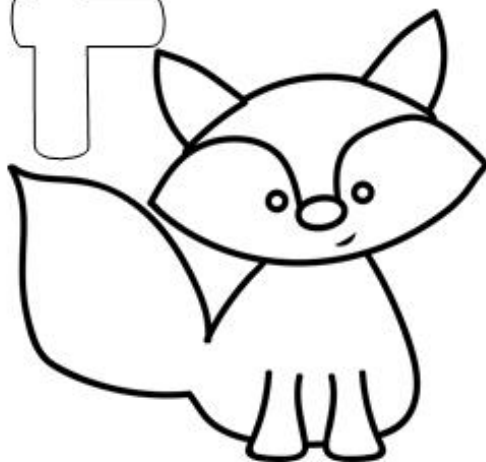
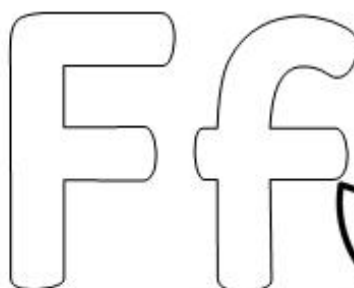
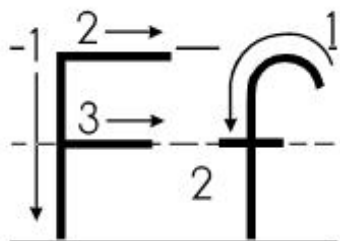

Name: _____

Write The Letter

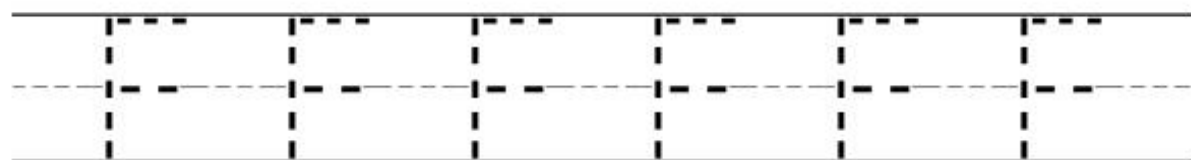
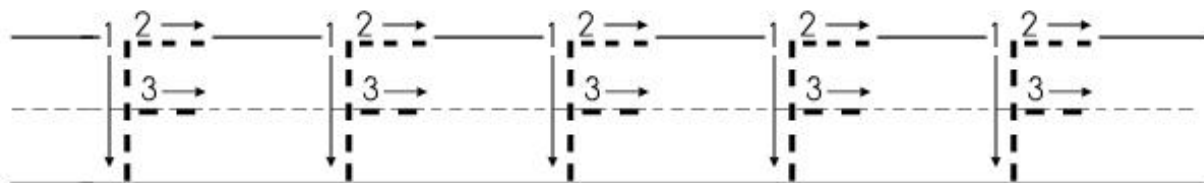
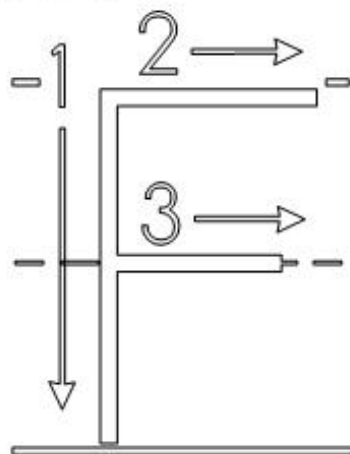
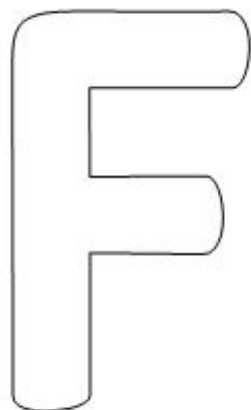

Name: _____

Find and Color

Color the pictures that begin with the letter F

Ff

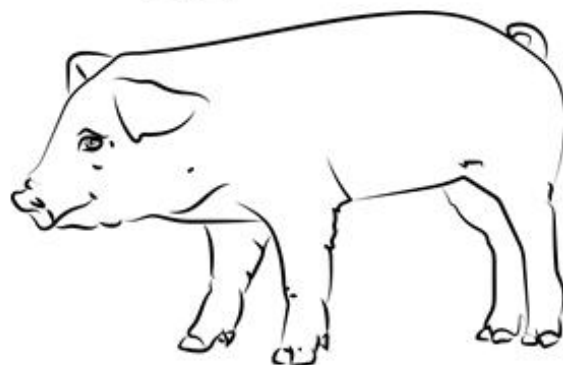
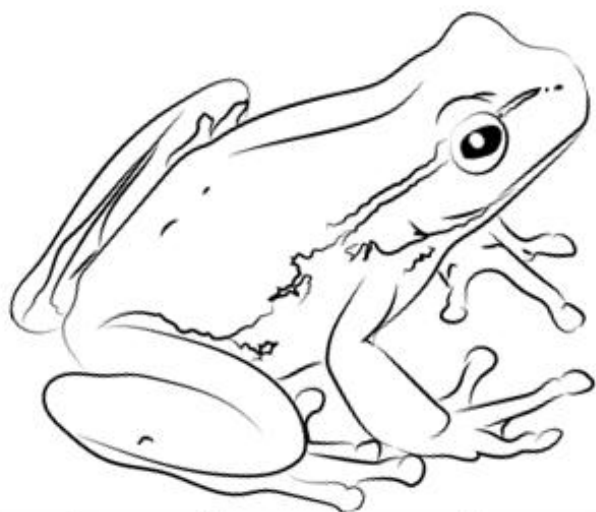
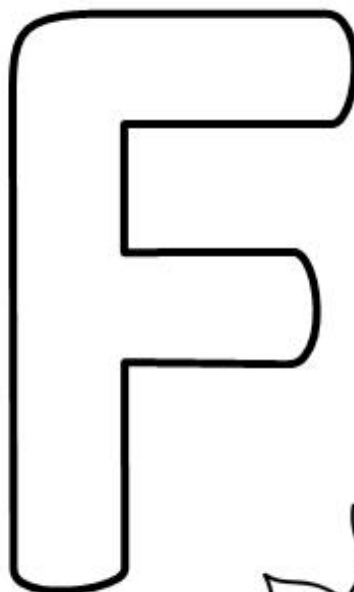
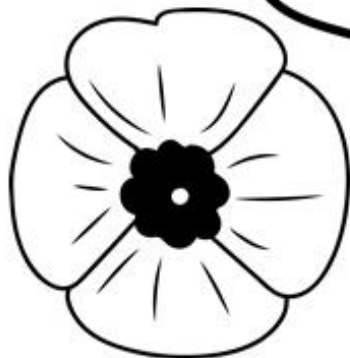
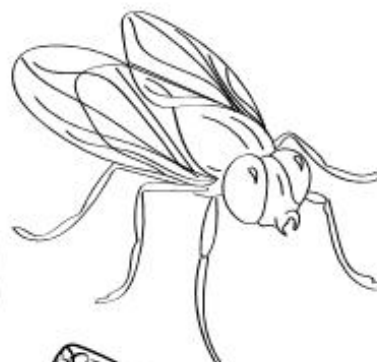

Name: -----

Letter Puzzles

Build the Upper and
Lower Case Puzzles

Ff

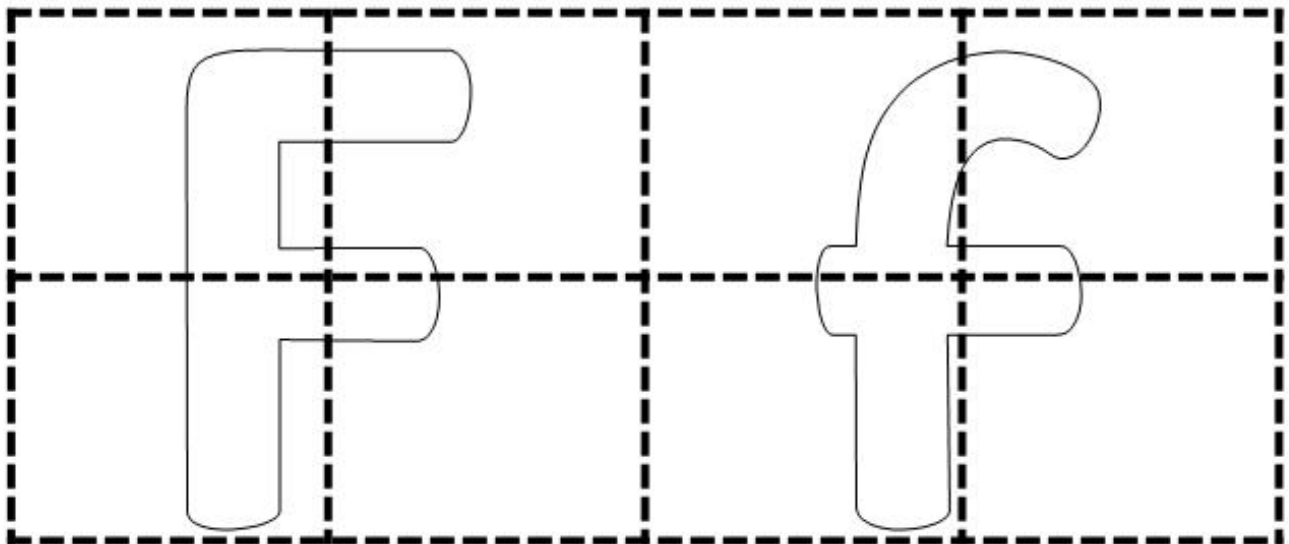

Name: _____

Letter Sorting

Sort the upper and lower case letters.

Ff

Upper

Lower

F

f

F

F

f

F

f

f

Name: _____

Graph The Letter

Count the letters and fill in the charts.

Ff

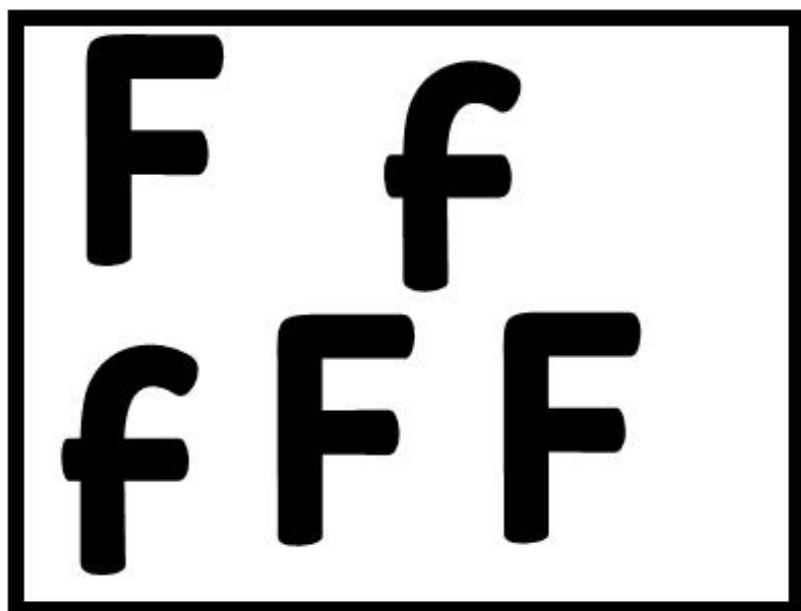

Tally Marks

Color the letter there are more of.



1	2	3	4	5
1	2	3	4	5

Name: _____

Write The Letter

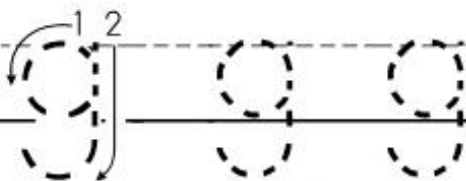
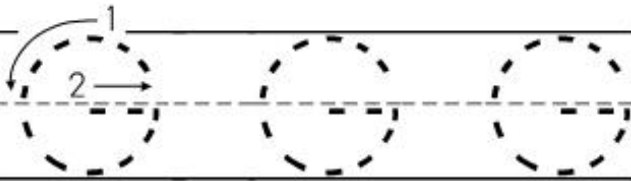
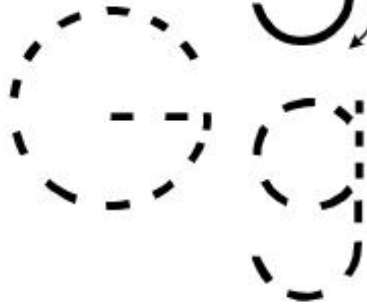
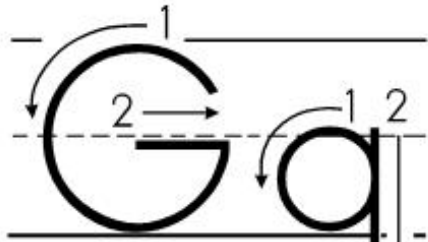

Name: _____

Write The Letter

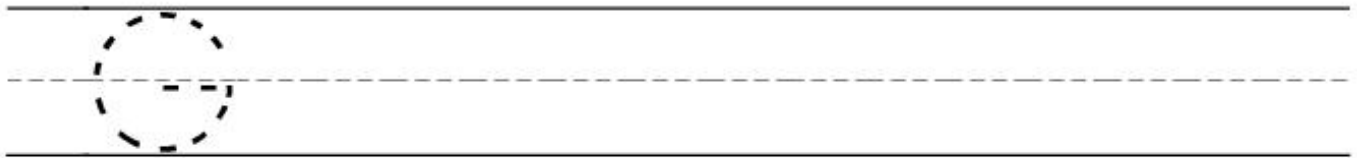
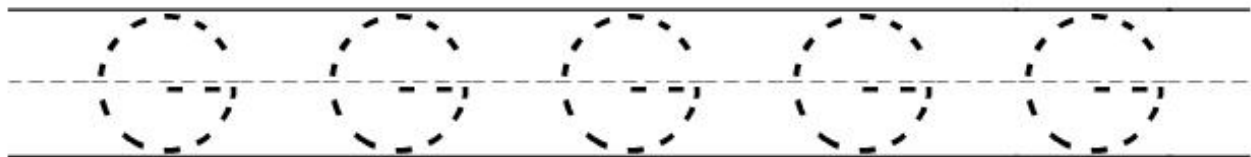
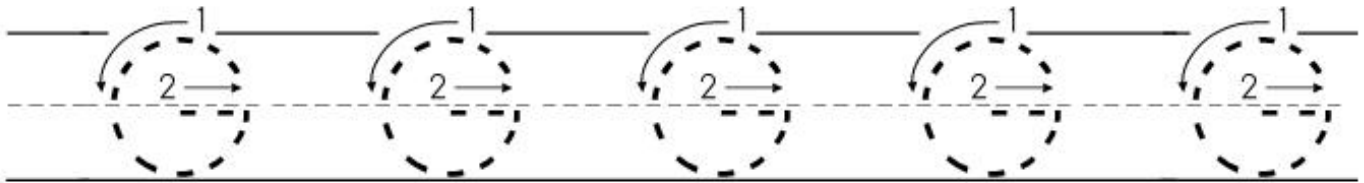
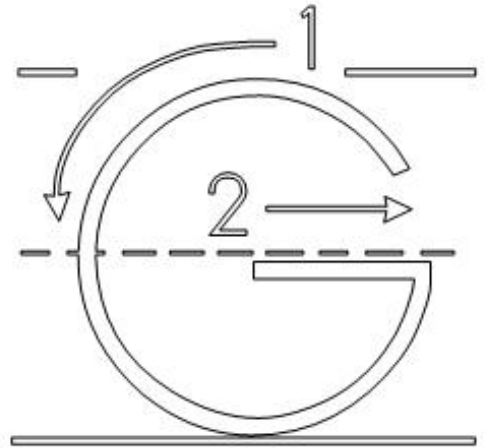
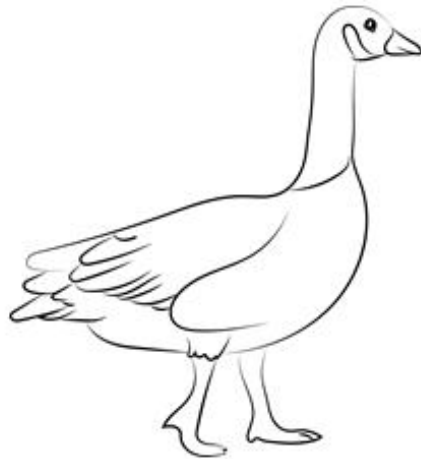

Name: _____

Find and Color

Color the pictures that begin with the letter G

Gg

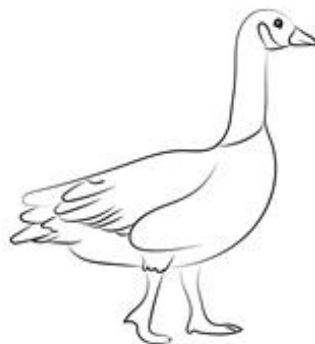
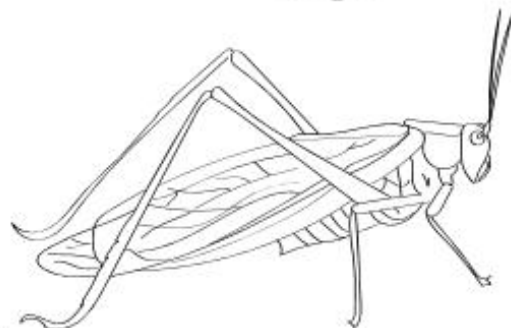
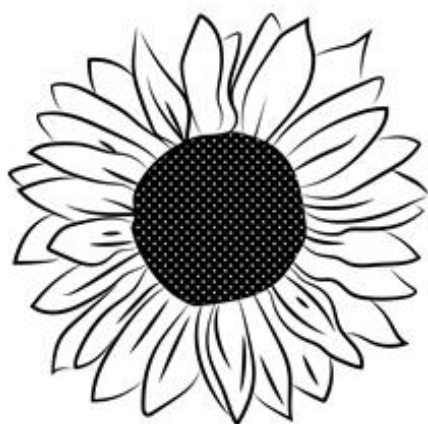

Name: -----

Letter Puzzles

Build the Upper and
Lower Case Puzzles

Gg

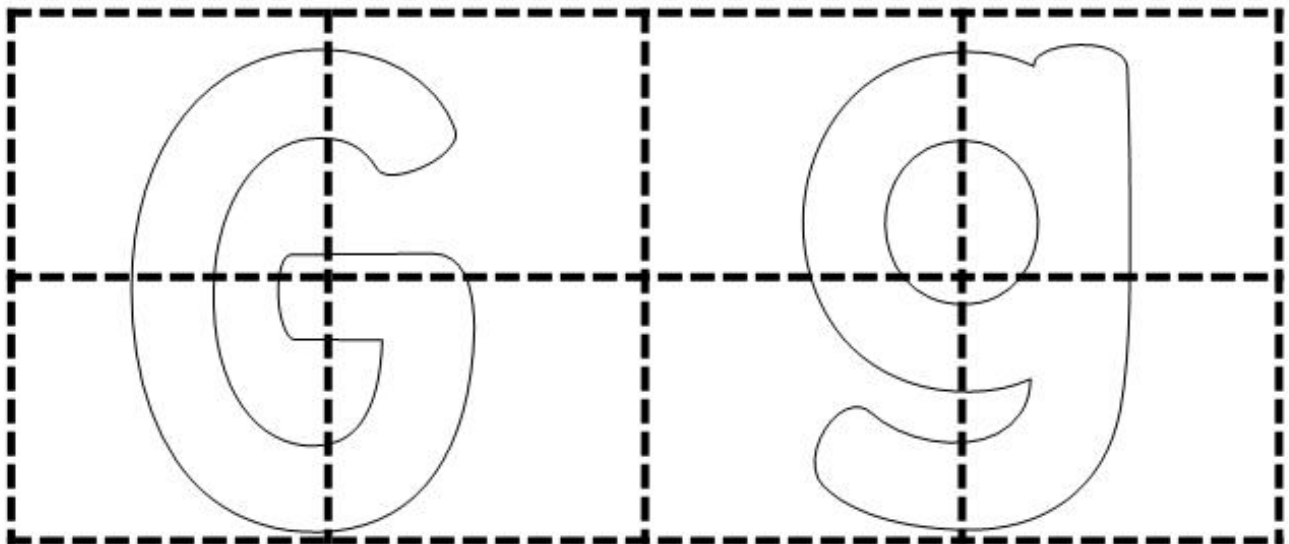

Name: _____

Letter Sorting

Sort the upper and lower case letters.

Gg

Upper

Lower

G

g

G

g

g

G

g

G

Name: _____

Graph The Letter

Count the letters and
fill in the charts.

Gg

Tally Marks

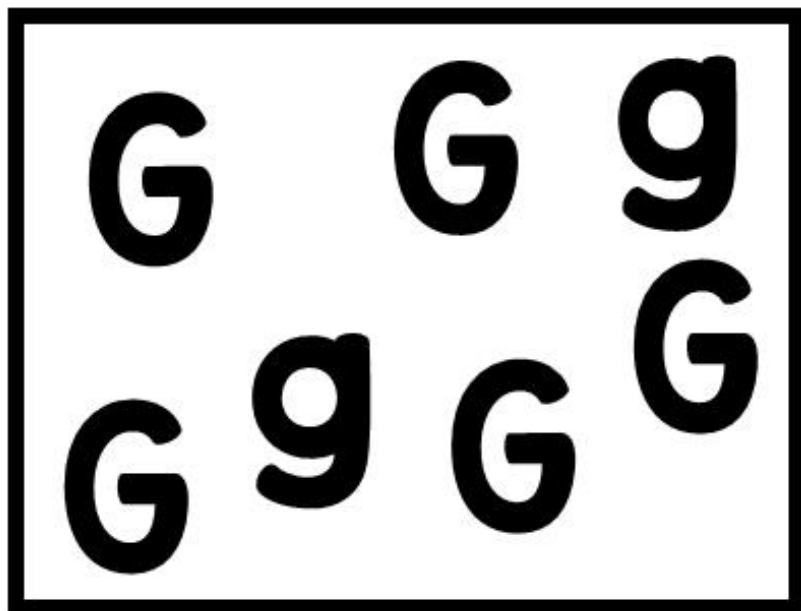

Color the
letter there
are more of.

Gg

Gg

1	2	3	4	5
1	2	3	4	5

Name: _____

Write The Letter

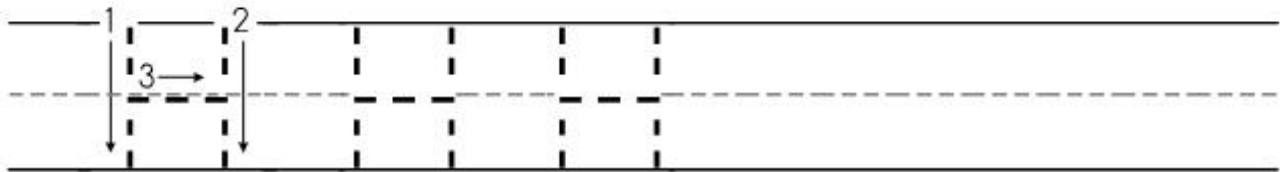
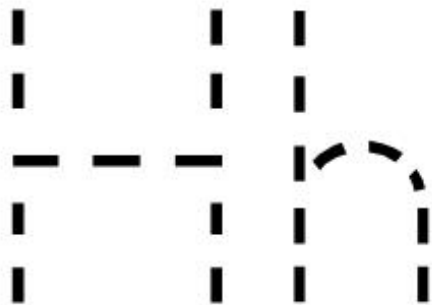
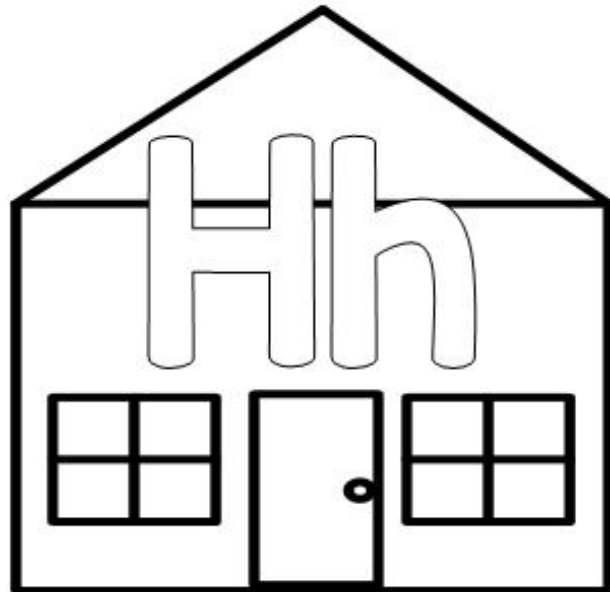
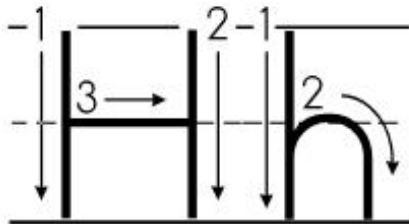

Name: _____

Write The Letter

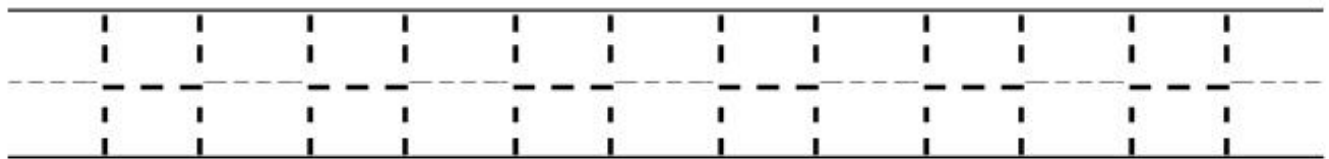
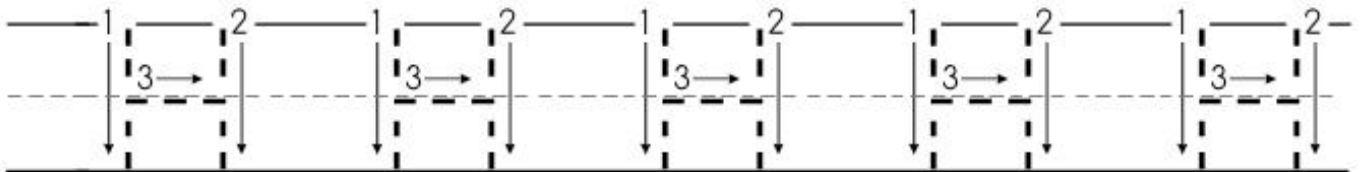
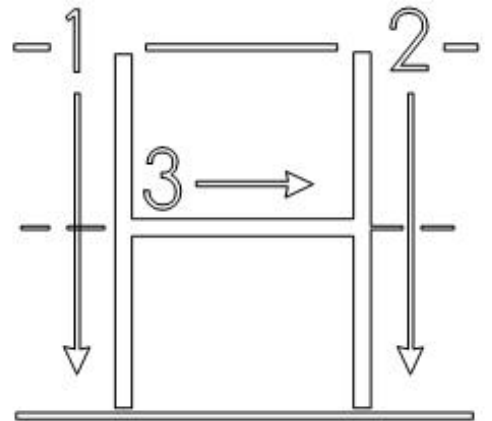
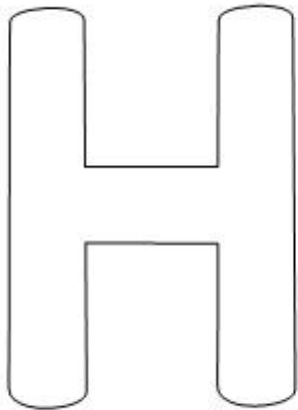

Name: _____

Find and Color

Color the pictures that begin with the letter H

Hh

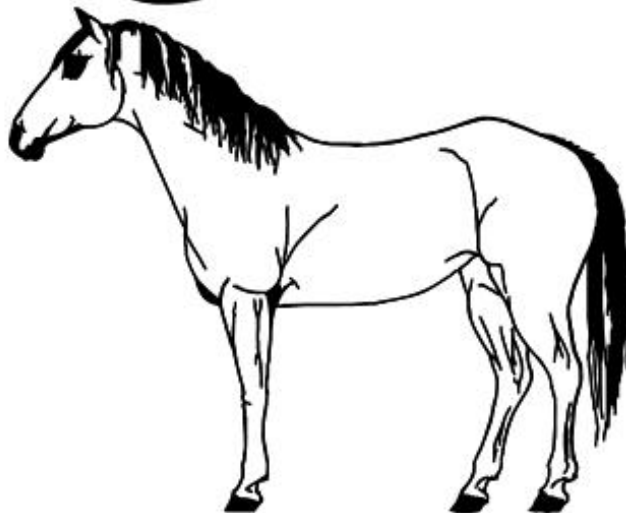
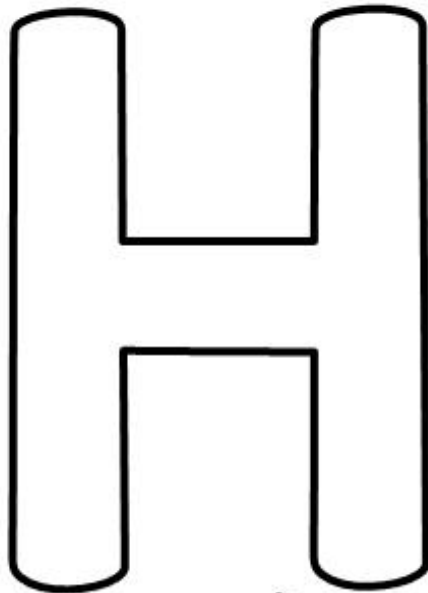

Name: -----

Letter Puzzles

Hh

Build the Upper and
Lower Case Puzzles

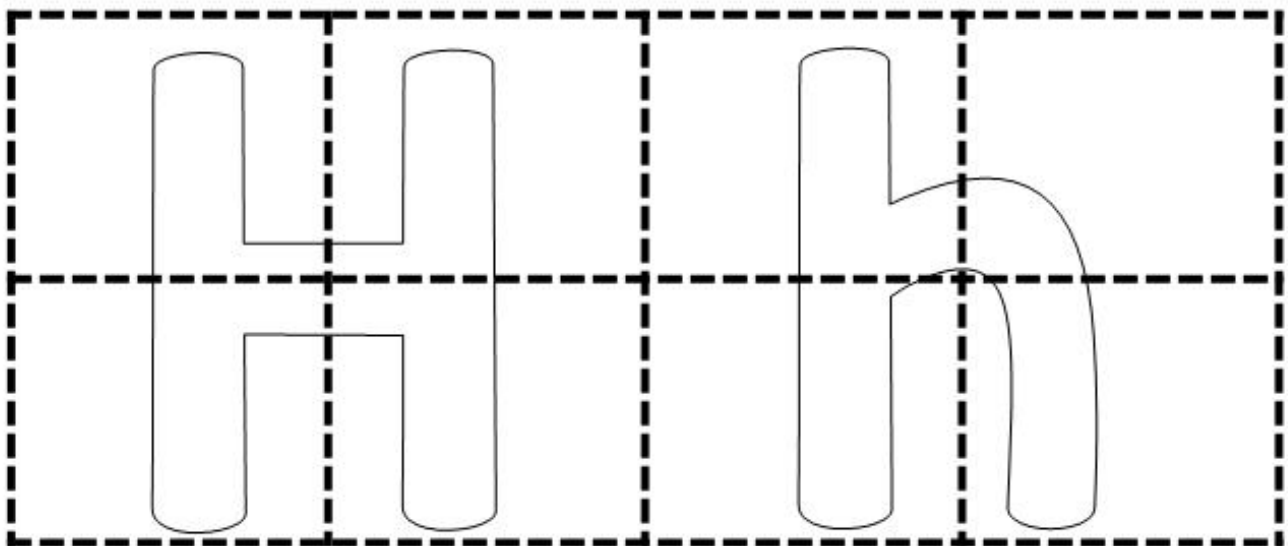

Name: _____

Letter Sorting

Hh

Sort the upper and lower case letters.

Upper

Lower

H

h

H

h

H

H

h

h

Name: _____

Graph The Letter

Count the letters and
fill in the charts.

Hh



Tally Marks

H
h

Color the
letter there
are more of.

Hh

H
h

1	2	3	4	5
1	2	3	4	5

Name: _____

Write The Letter

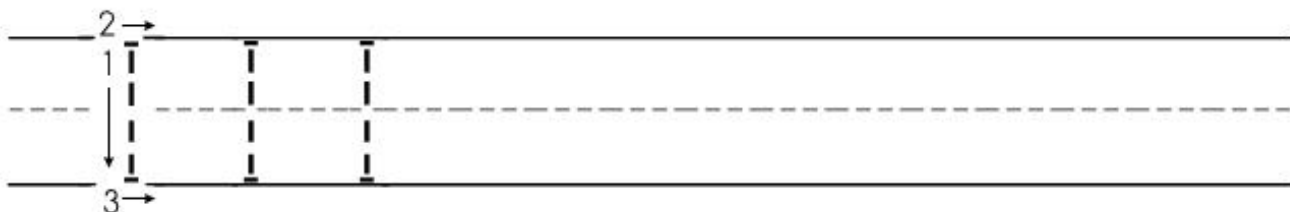
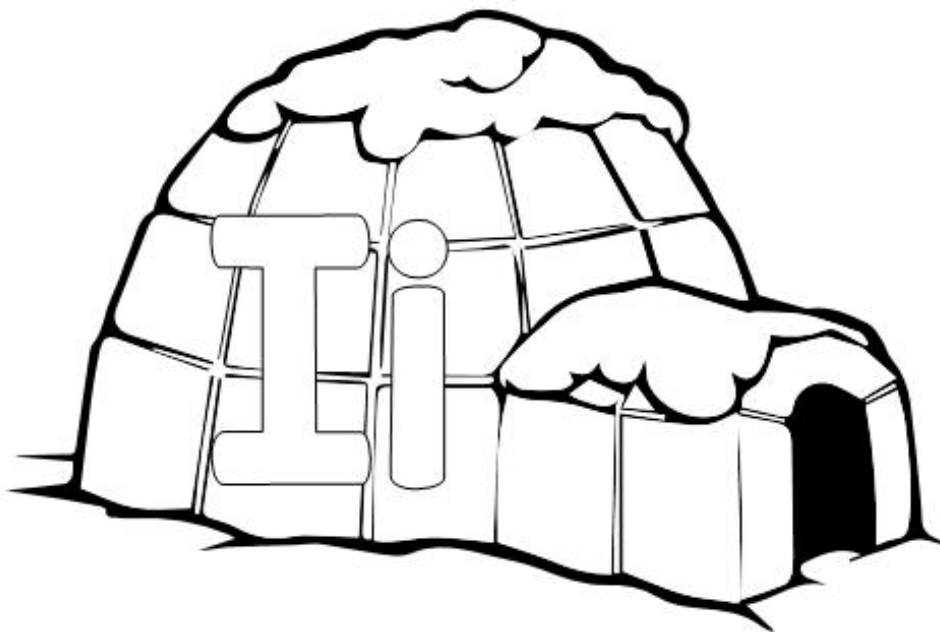
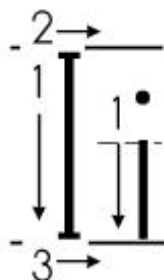

Name: _____

Write The Letter

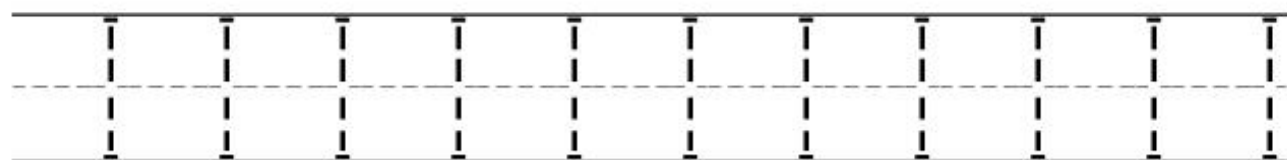
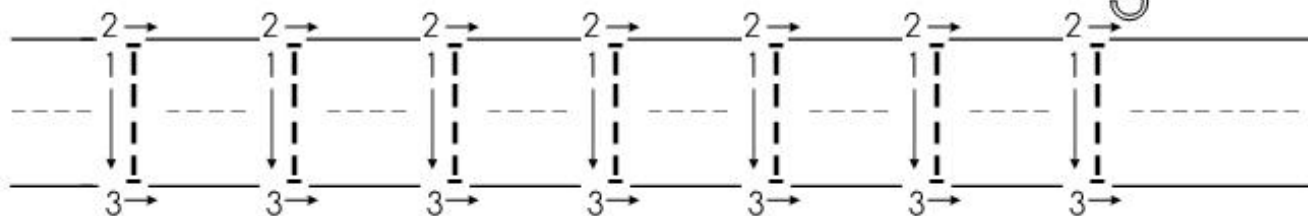
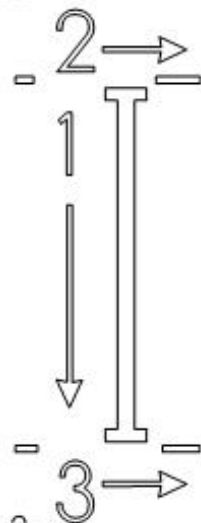
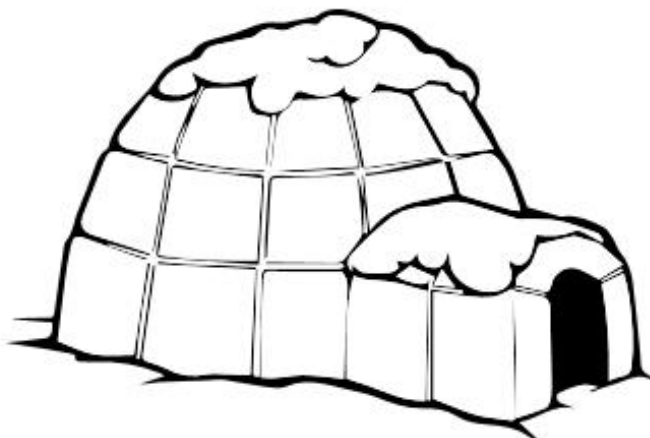
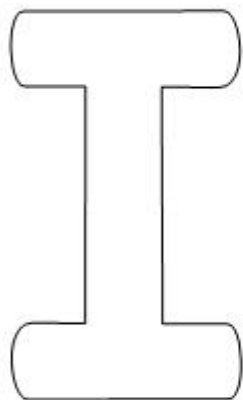

Name: _____

Find and Color

Color the pictures that begin with the letter I

Ii

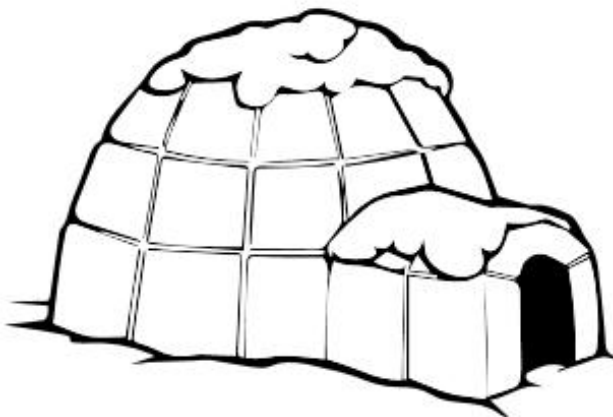
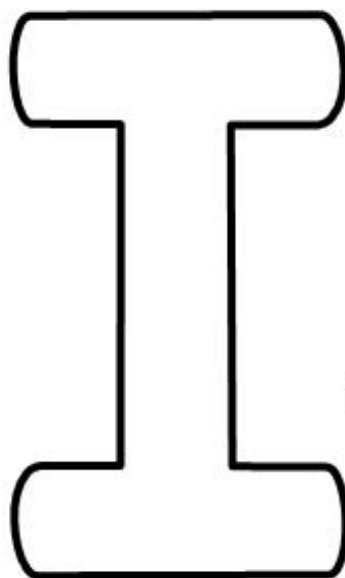
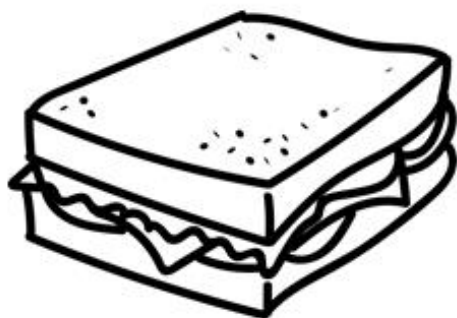

Name: -----

Letter Puzzles

Build the Upper and
Lower Case Puzzles

Ii

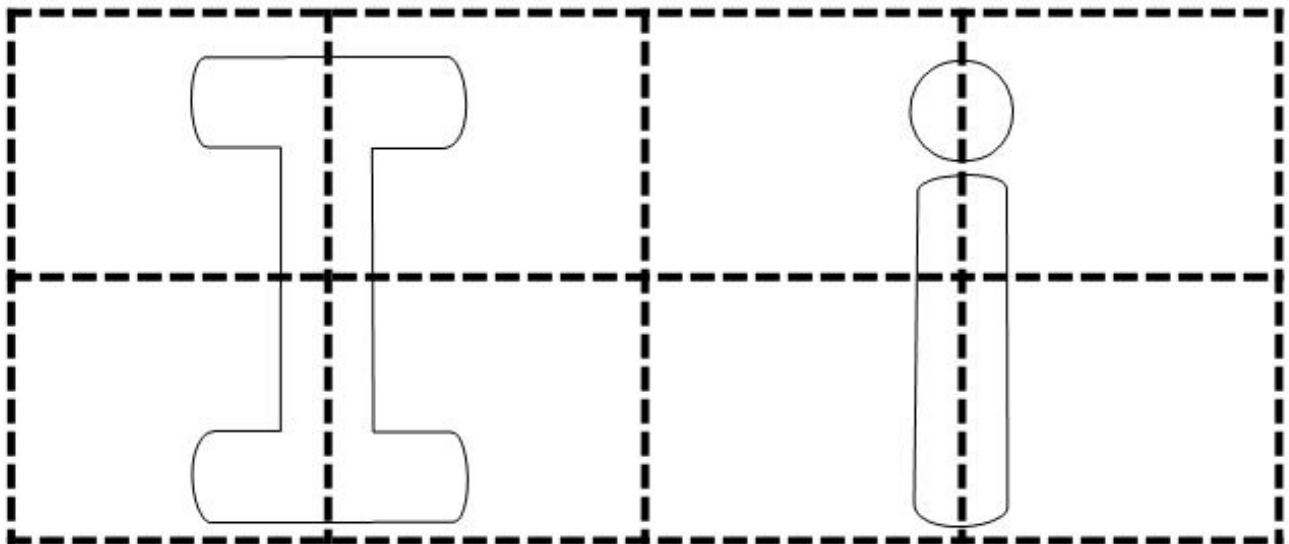

Name: _____

Letter Sorting

Ii

Sort the upper and lower case letters.

Upper

Lower

I

i

I

i

I

I

i

i

Name: _____

Graph The Letter

Count the letters and fill in the charts.

Ii

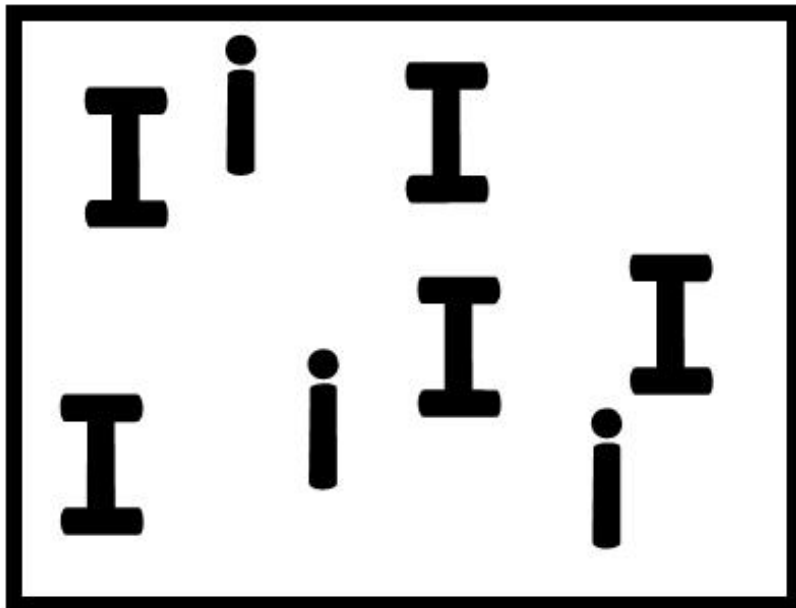

Tally Marks

I	
i	

Color the letter there are more of.

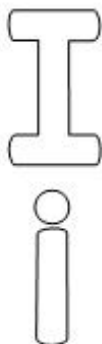
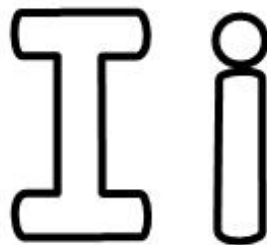

1	2	3	4	5
1	2	3	4	5

Name: _____

Write The Letter

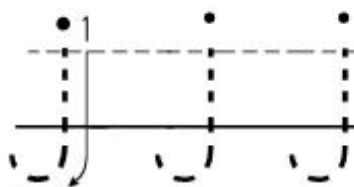
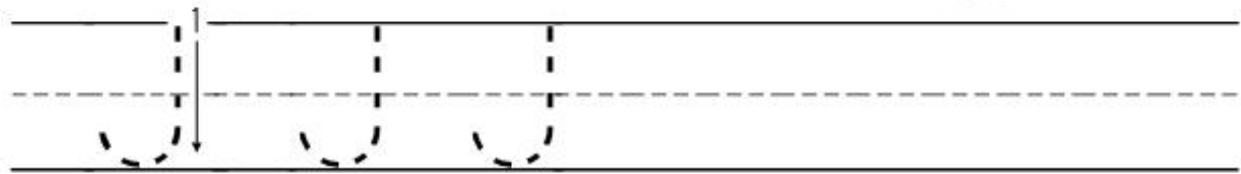
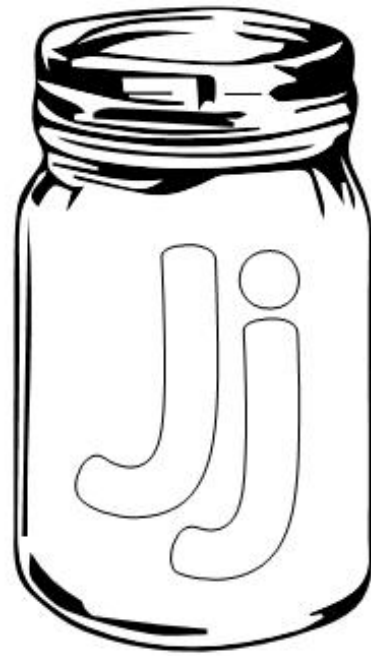
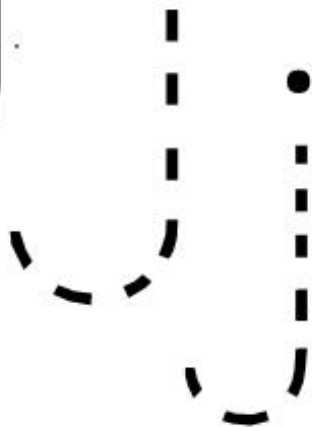
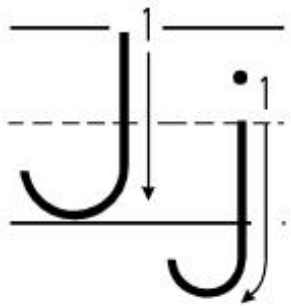

Name: _____

Write The Letter

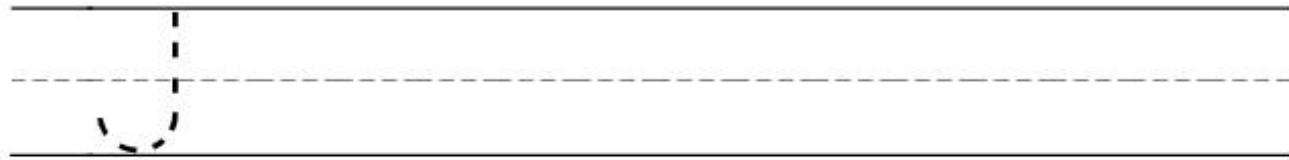
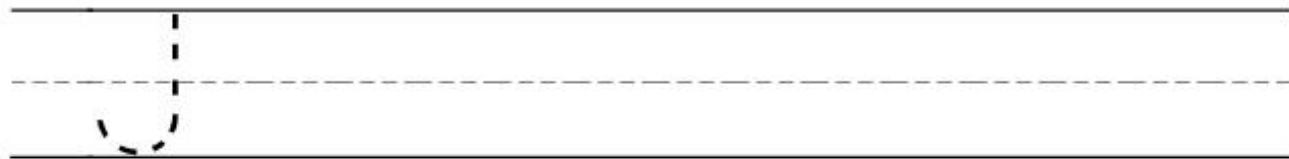
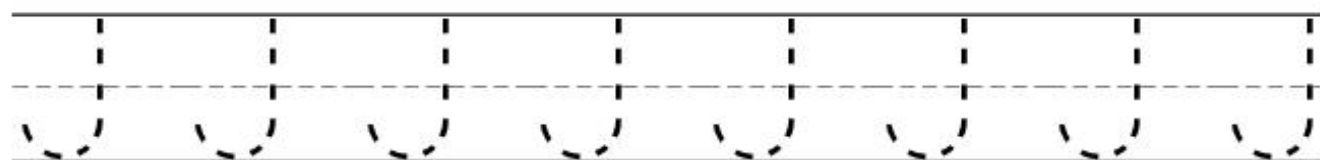
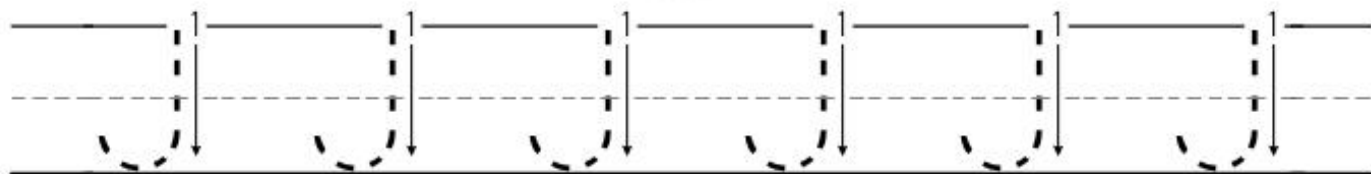
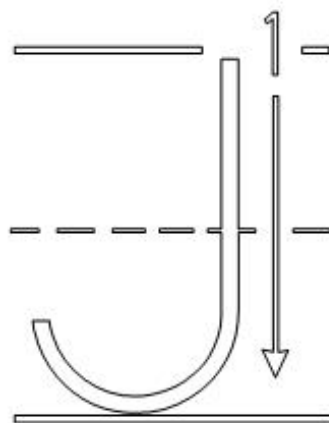

Name: _____

Find and Color

Color the pictures that begin with the letter J

Jj

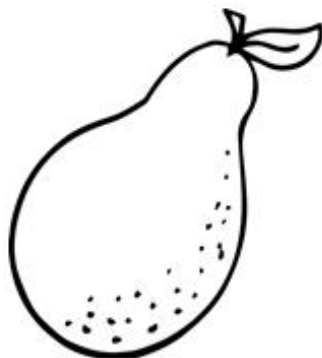
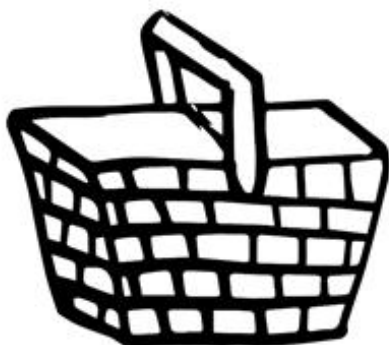

Name: -----

Letter Puzzles

Build the Upper and
Lower Case Puzzles

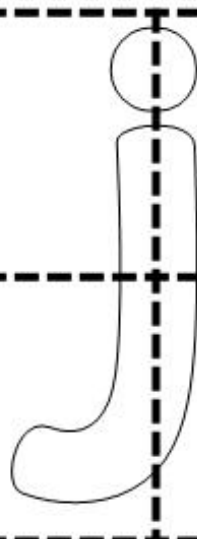
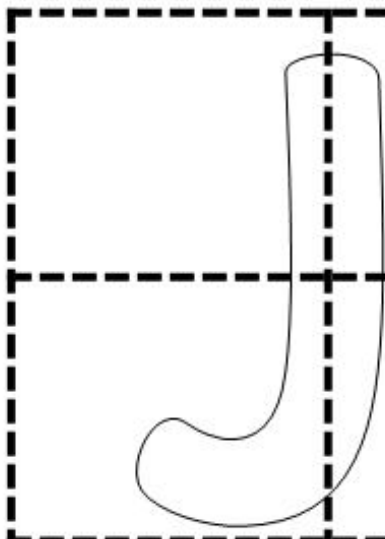

Name: _____

Letter Sorting

Sort the upper and lower case letters.

Jj

Upper

Lower

J

j

J

j

j

J

J

J

Name: _____

Graph The Letter

Count the letters and
fill in the charts.

Jj

Tally Marks

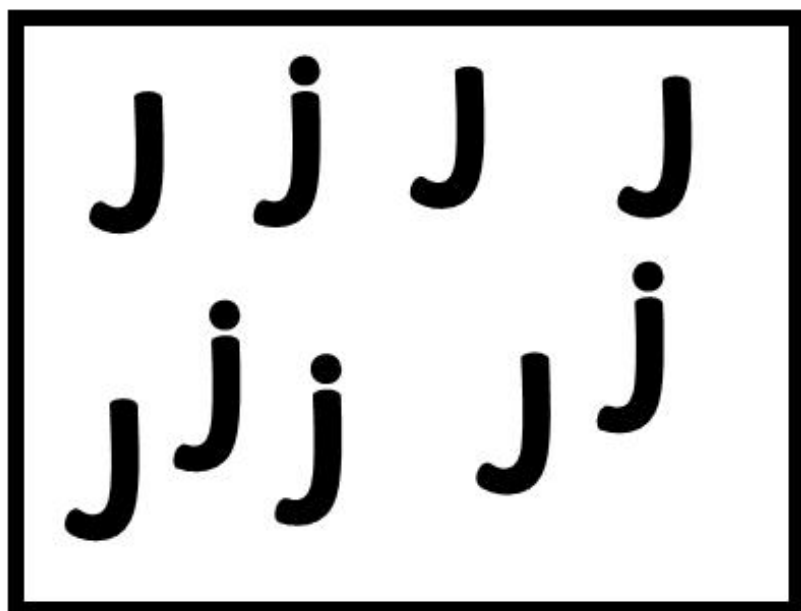

Color the
letter there
are more of.

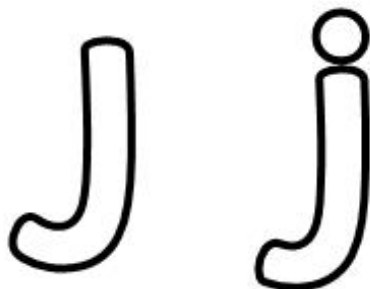

1	2	3	4	5
1	2	3	4	5

Name: _____

Write The Letter

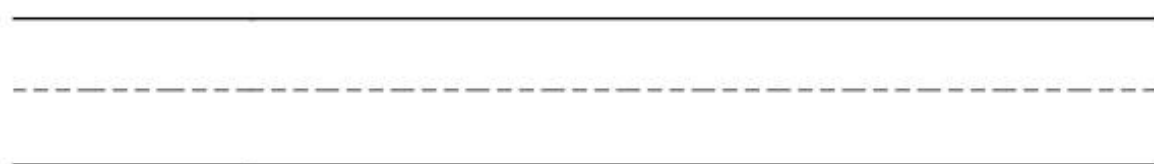
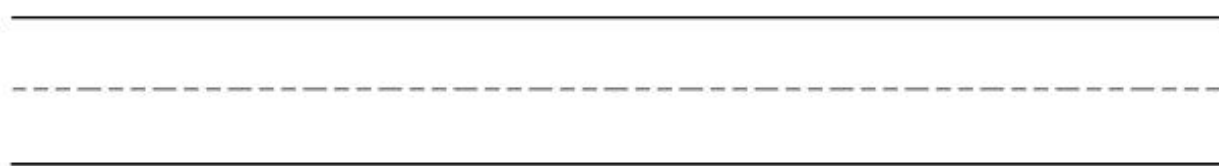
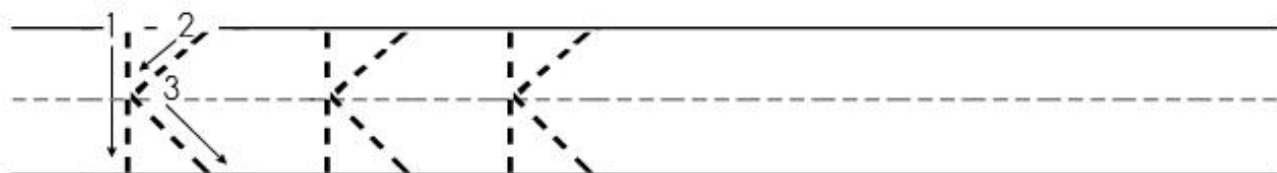
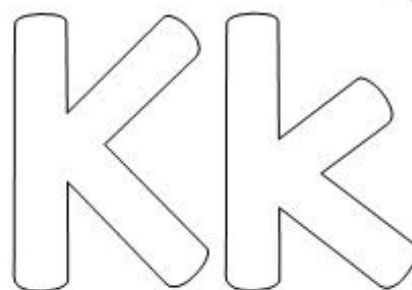
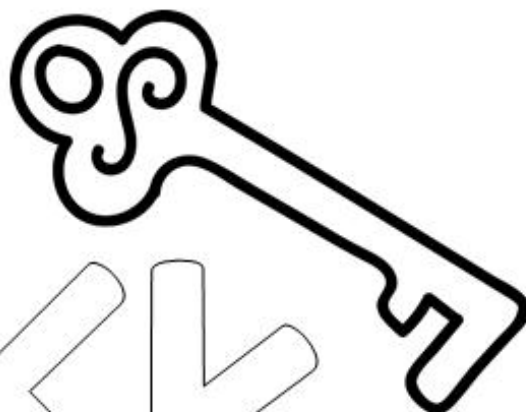
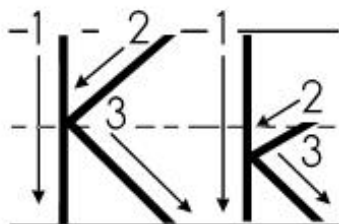

Name: _____

Write The Letter

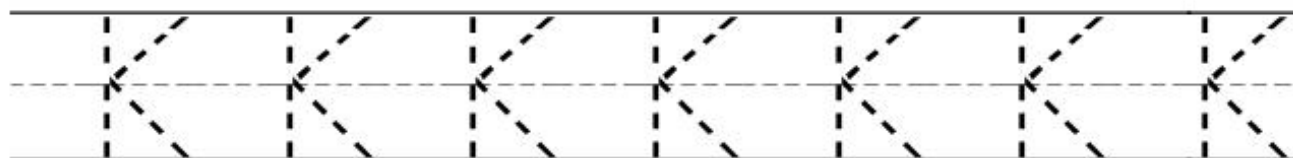
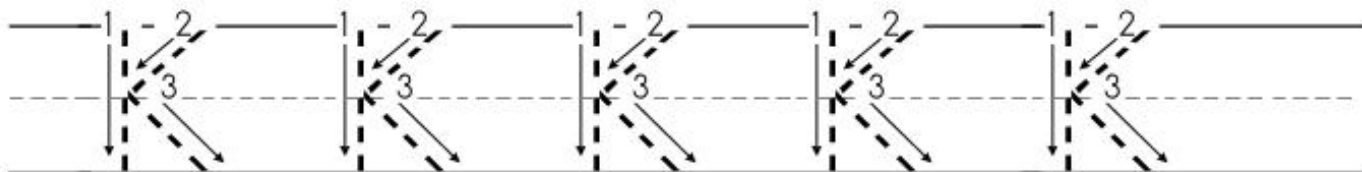
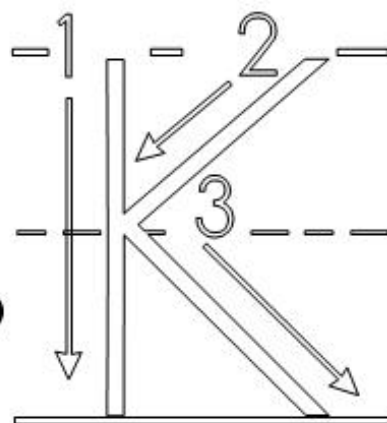
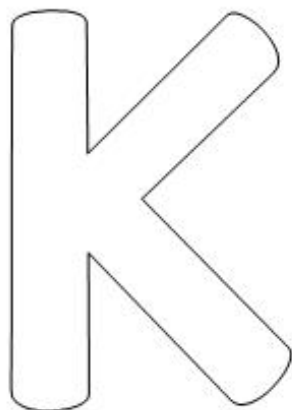

Name: _____

Find and Color

Color the pictures that begin with the letter K

Kk

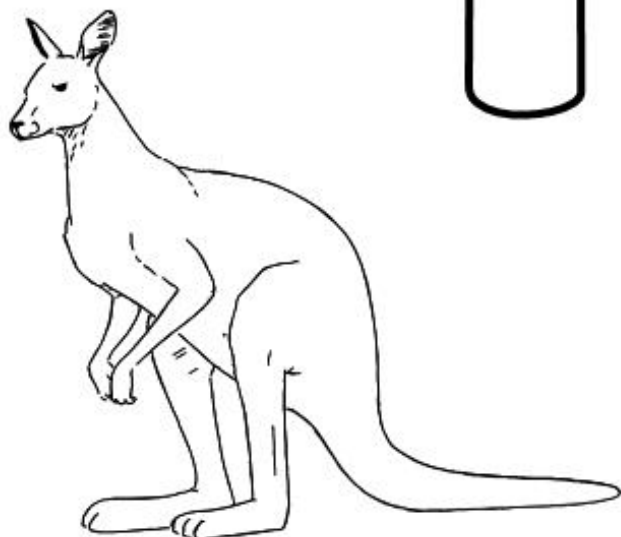
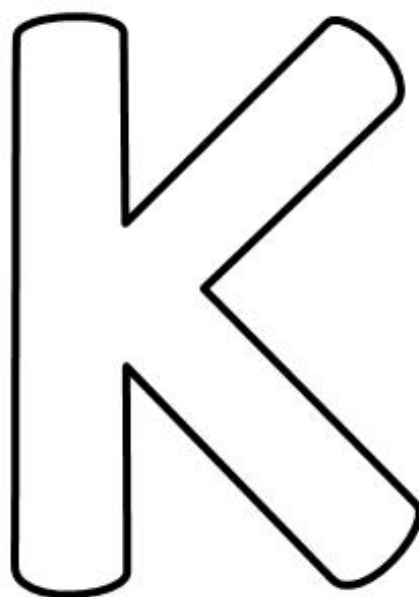
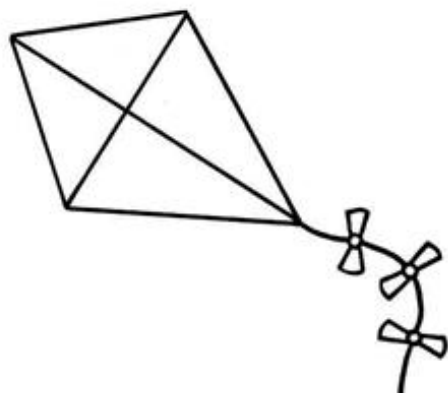

Name: -----

Letter Puzzles

Build the Upper and
Lower Case Puzzles

Kk

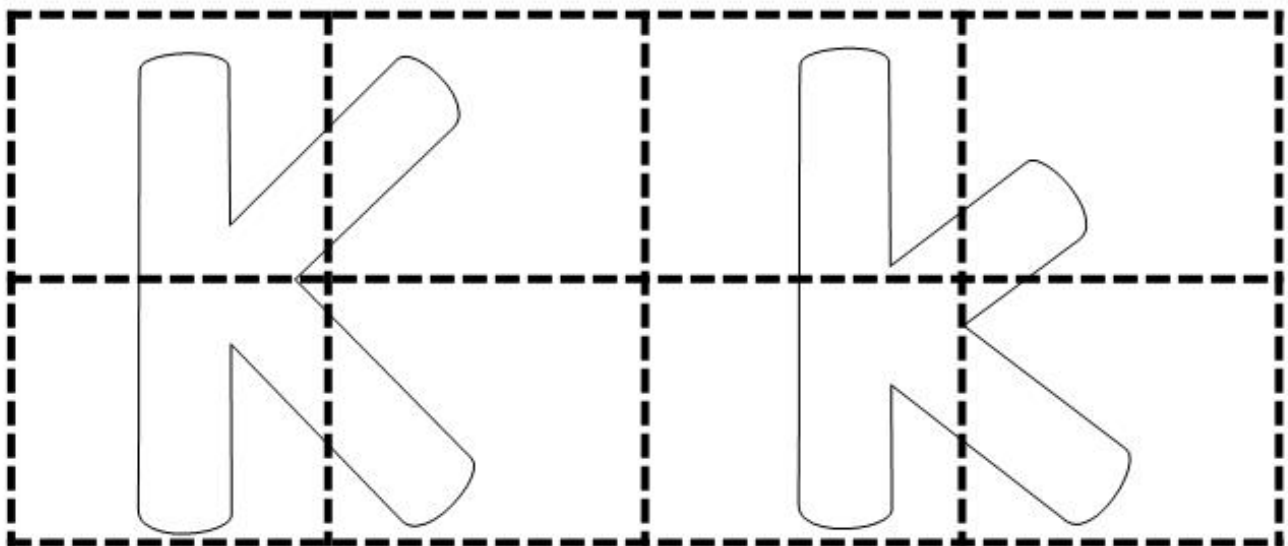

Name: _____

Letter Sorting

Kk

Sort the upper and lower case letters.

Upper

Lower

K

k

K

k

K

K

K

k

Name: _____

Graph The Letter

Count the letters and fill in the charts.

Kk

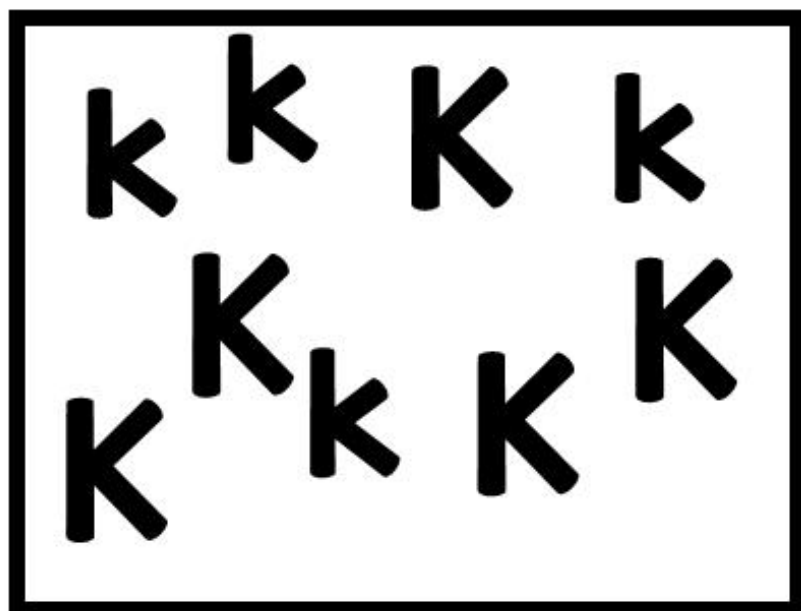

Tally Marks

Color the letter there are more of.

K k

K k

1	2	3	4	5
1	2	3	4	5

Name: _____

Write The Letter

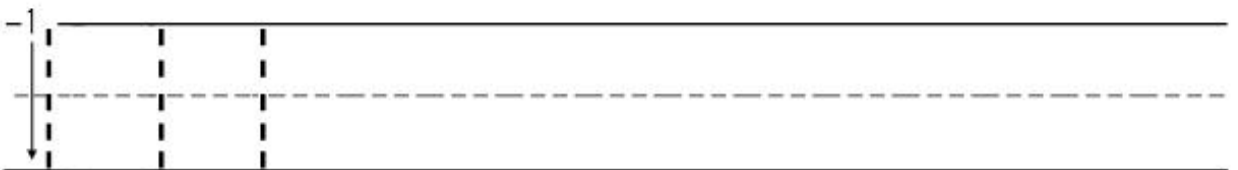
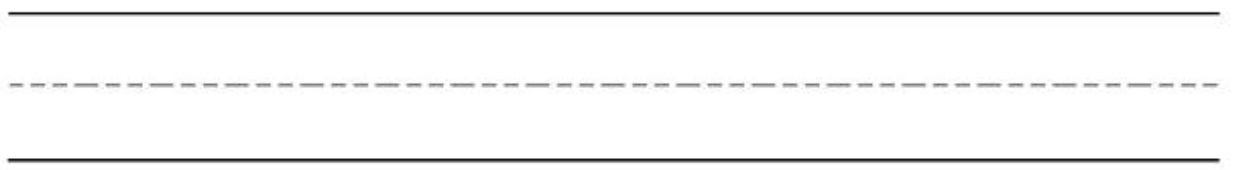
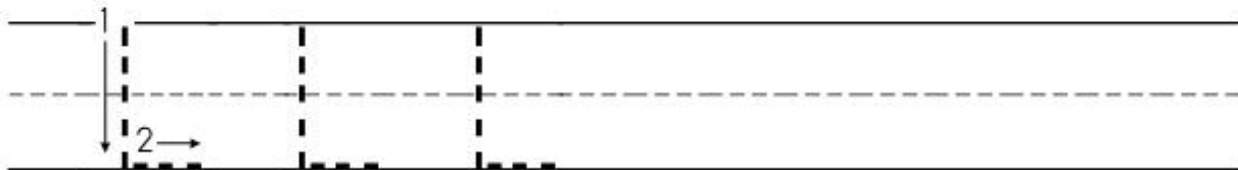
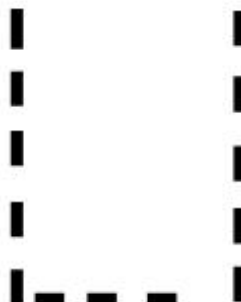
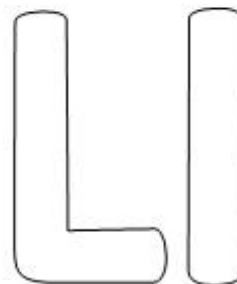
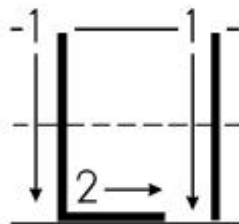

Name: _____

Write The Letter

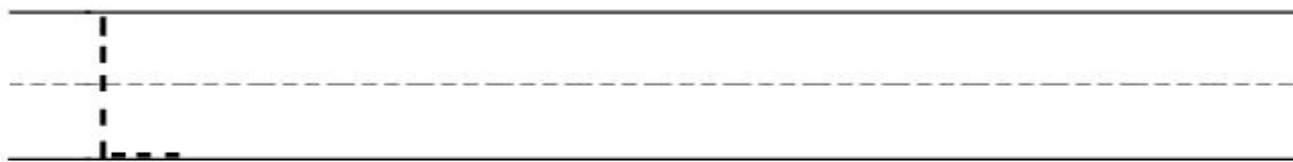
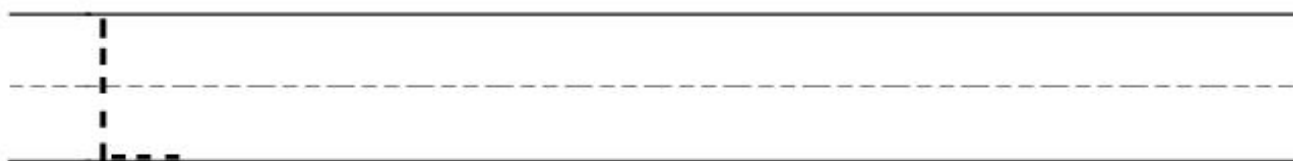
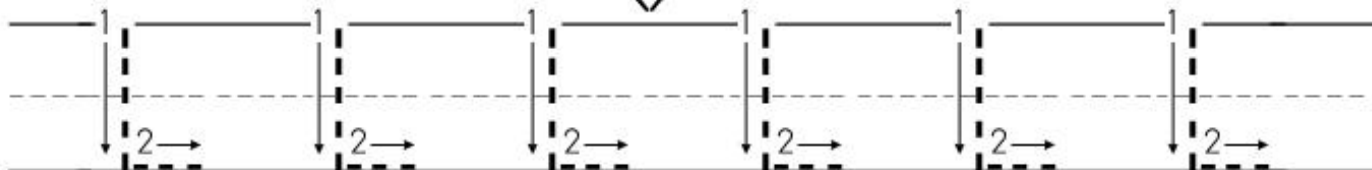
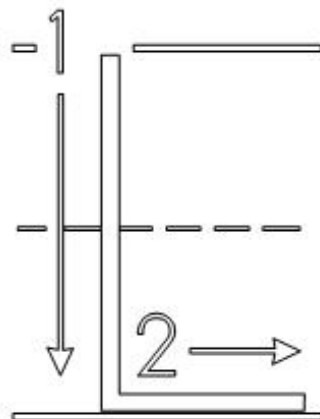

Name: _____

Find and Color

Color the pictures that begin with the letter L

LI

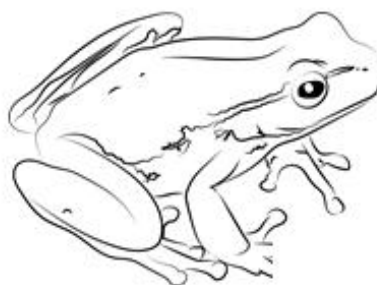
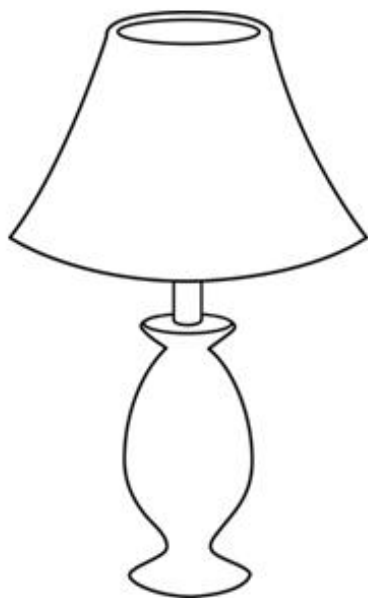

Name: -----

Letter Puzzles

L I

Build the Upper and
Lower Case Puzzles

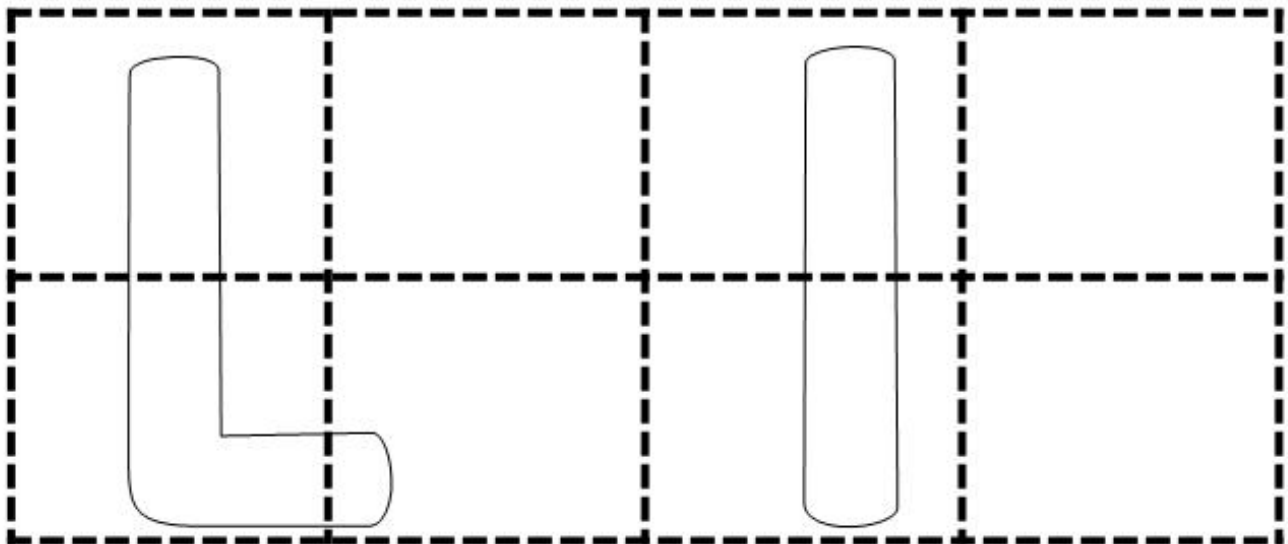

Name: _____

Letter Sorting

Sort the upper and lower case letters.

L I

Upper

Lower

L	I	l	i
L	L	I	I

Name: _____

Graph The Letter

Count the letters and fill in the charts.

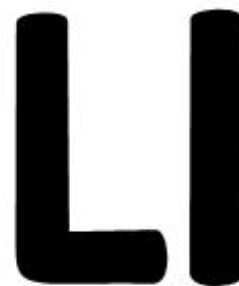

Tally Marks

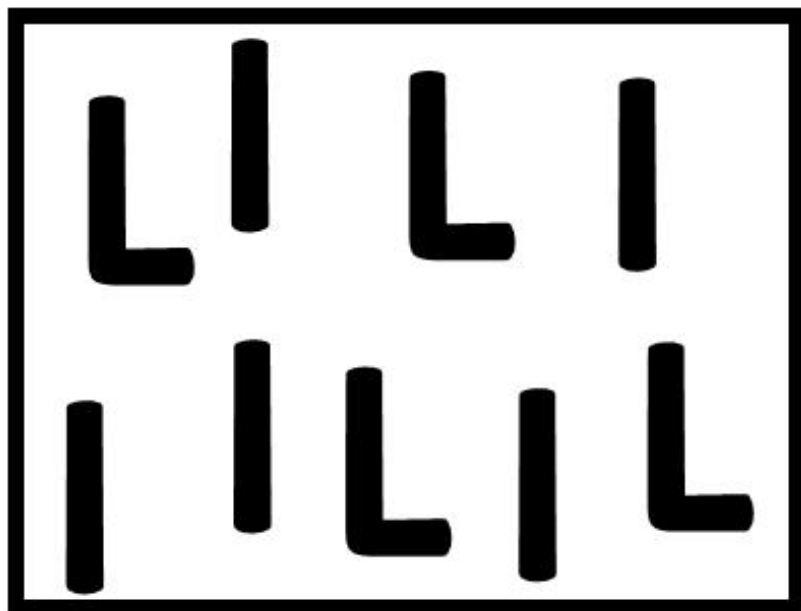

Color the letter there are more of.



1	2	3	4	5
1	2	3	4	5

Name: _____

Write The Letter

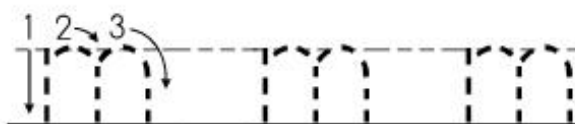
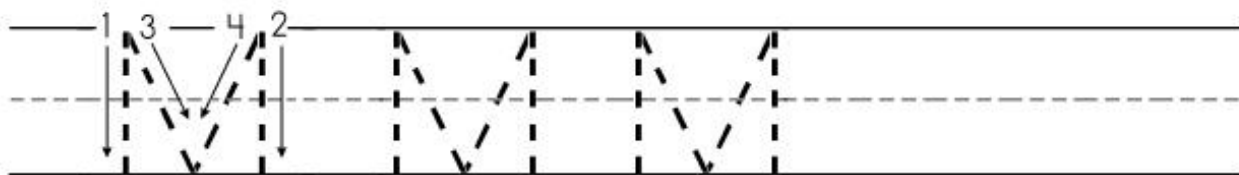
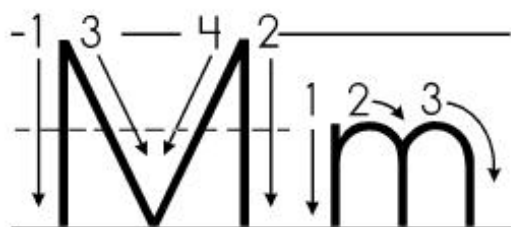

Name: _____

Write The Letter

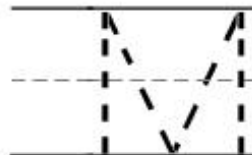
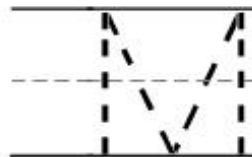
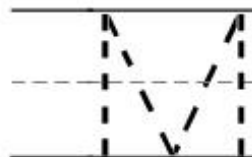
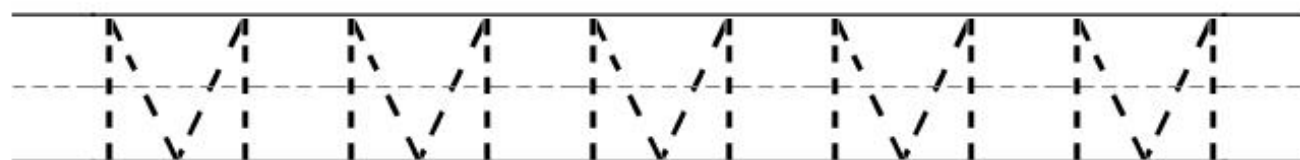
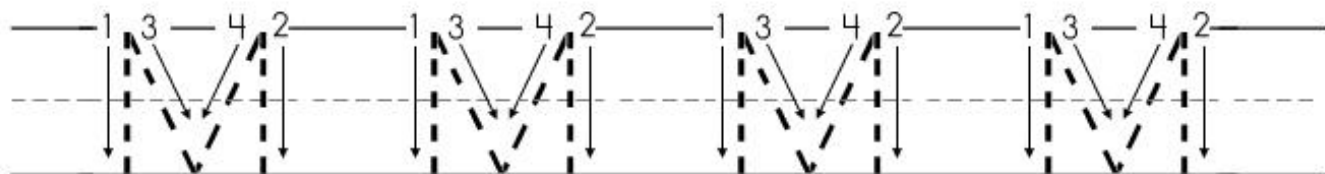
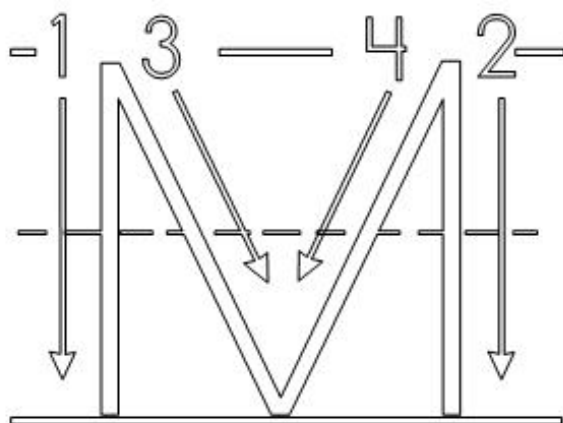
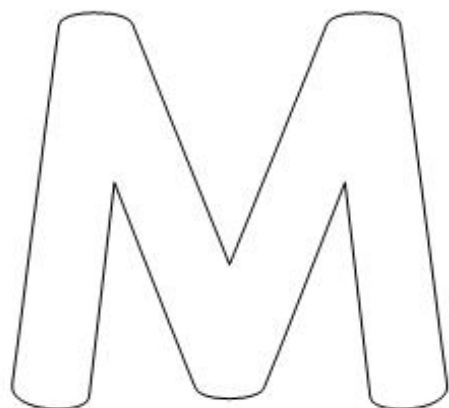

Name: _____

Find and Color

Color the pictures that begin with the letter M

Mm

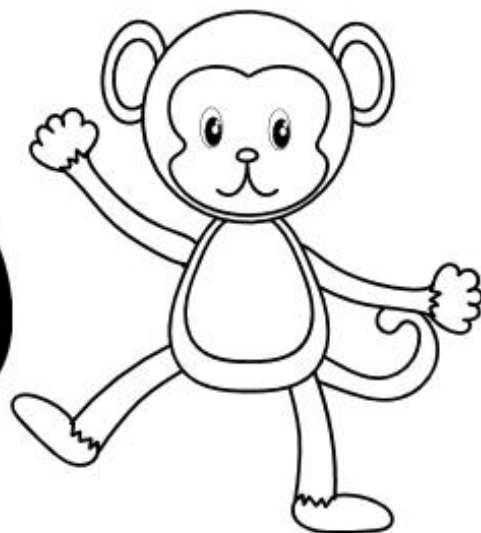
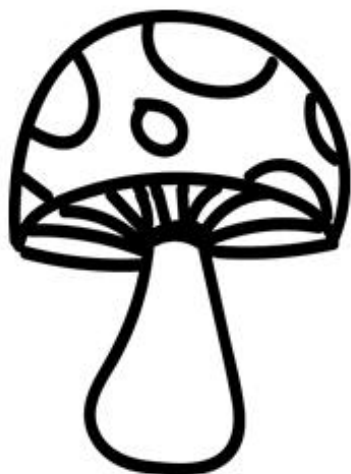
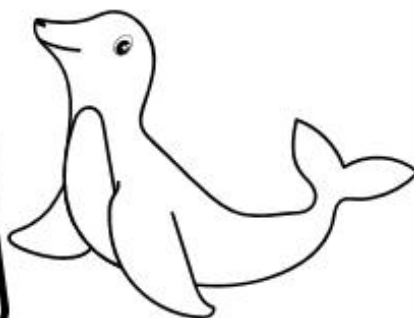
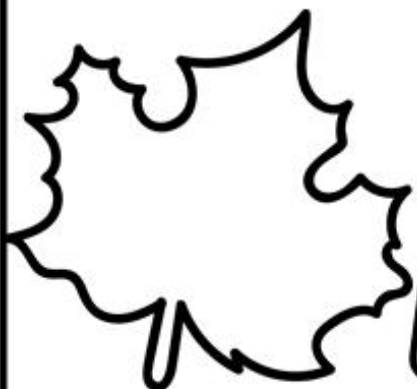
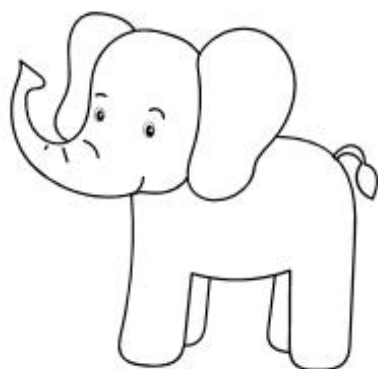

Name: -----

Letter Puzzles

Build the Upper and
Lower Case Puzzles

Mm

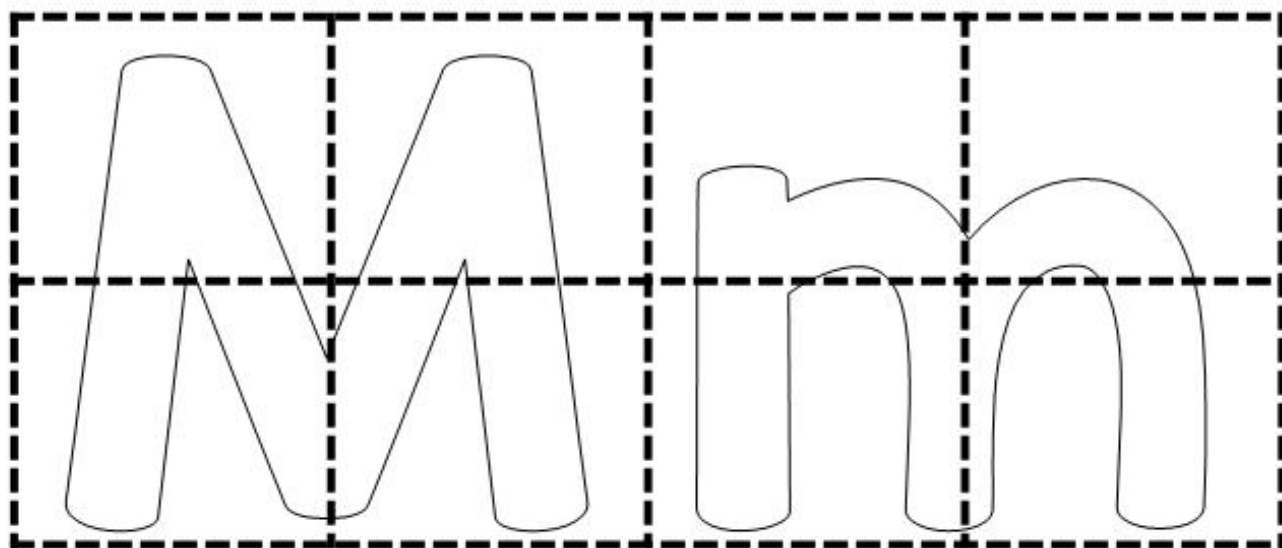

Name: _____

Letter Sorting

Sort the upper and lower case letters.

Mm

Upper

Lower

M

m

m

m

M

M

m

m

Name: _____

Graph The Letter

Count the letters and fill in the charts.

Mm

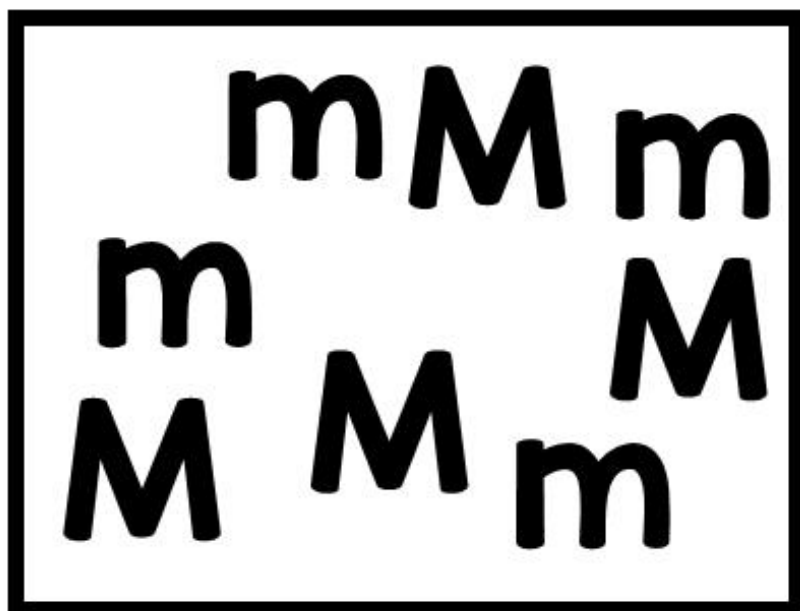

Tally Marks

M

Color the letter there are more of.

Mm m

M

m

1	2	3	4	5
1	2	3	4	5

Name: _____

Write The Letter

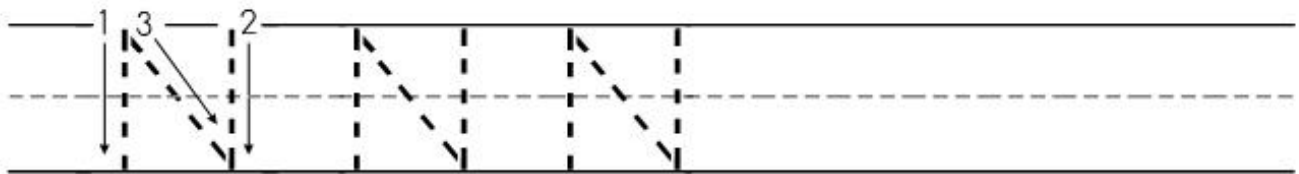
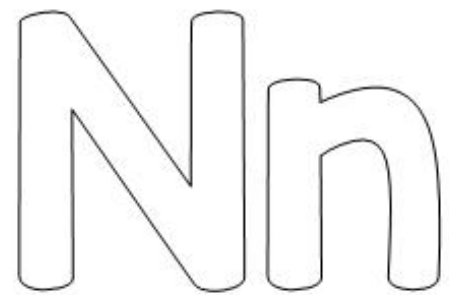
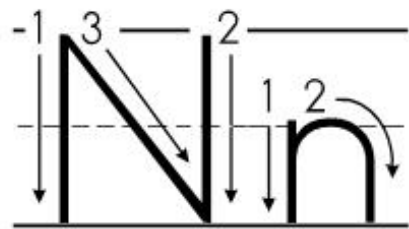

Name: _____

Write The Letter

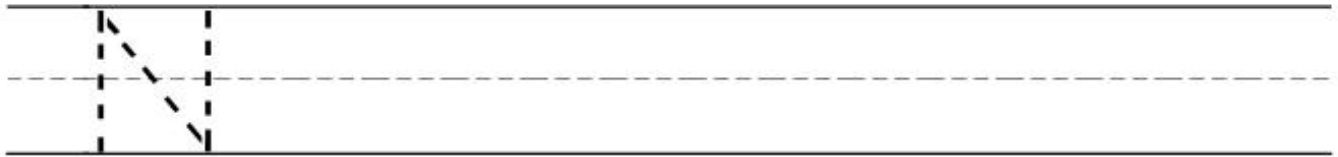
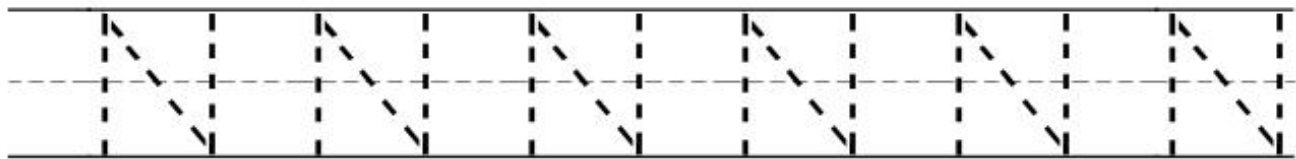
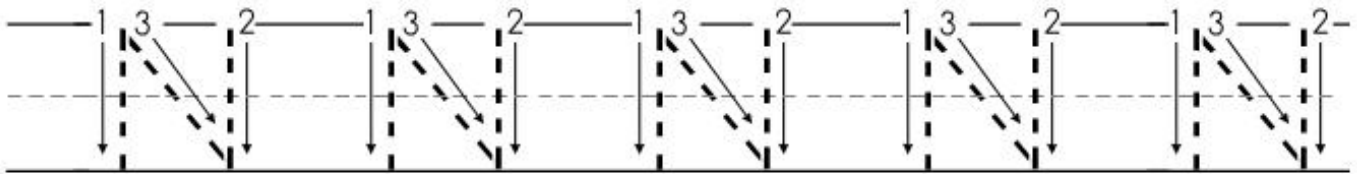
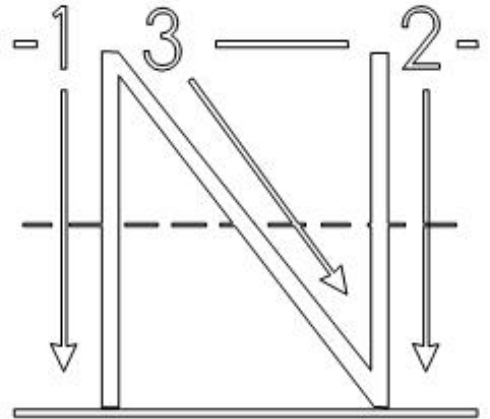
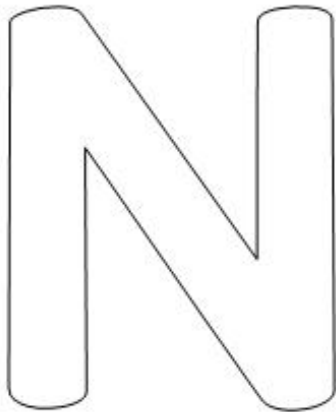

Name: _____

Find and Color

Color the pictures that begin with the letter N

Nn

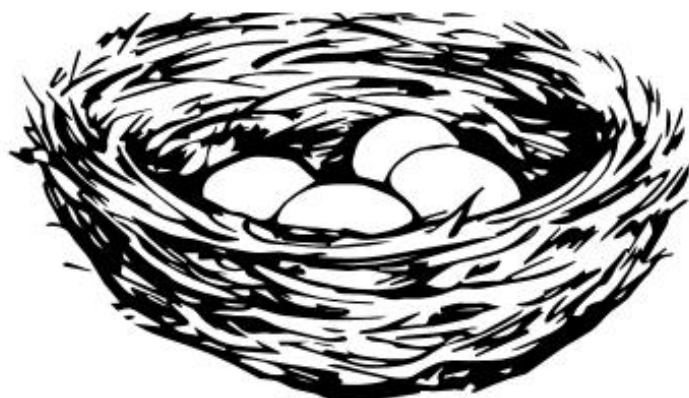
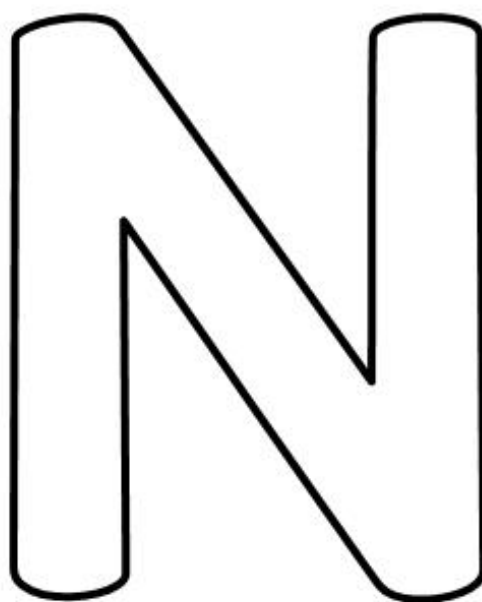

Name: -----

Letter Puzzles

Build the Upper and
Lower Case Puzzles

Nn

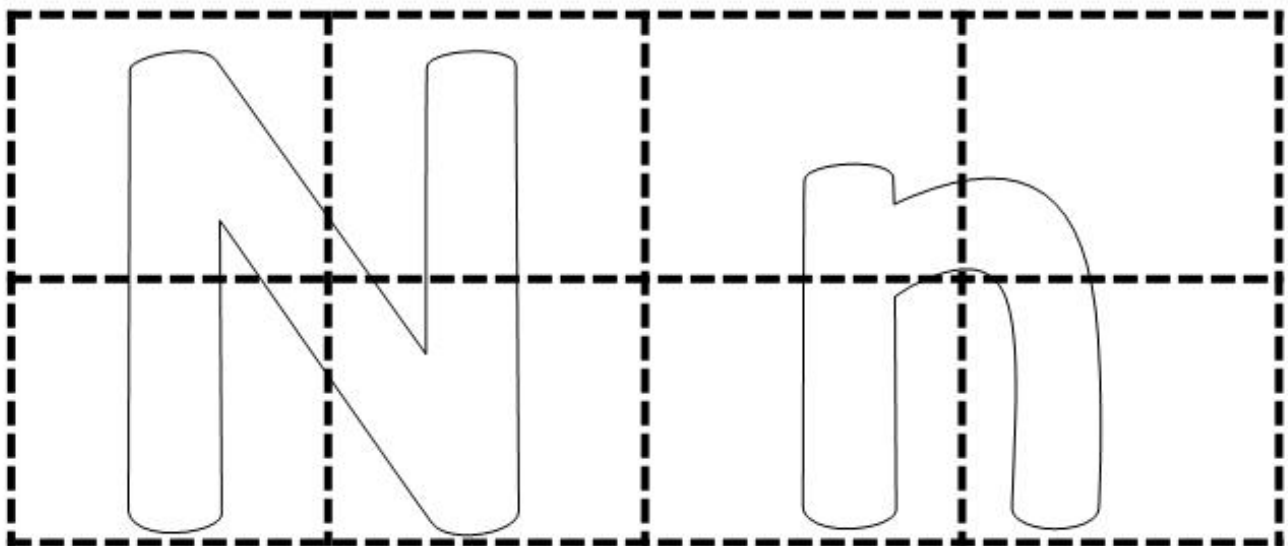

Name: _____

Letter Sorting

Nn

Sort the upper and lower case letters.

Upper

Lower

N

n

n

N

N

N

n

n

Name: _____

Graph The Letter

Count the letters and
fill in the charts.

Nn

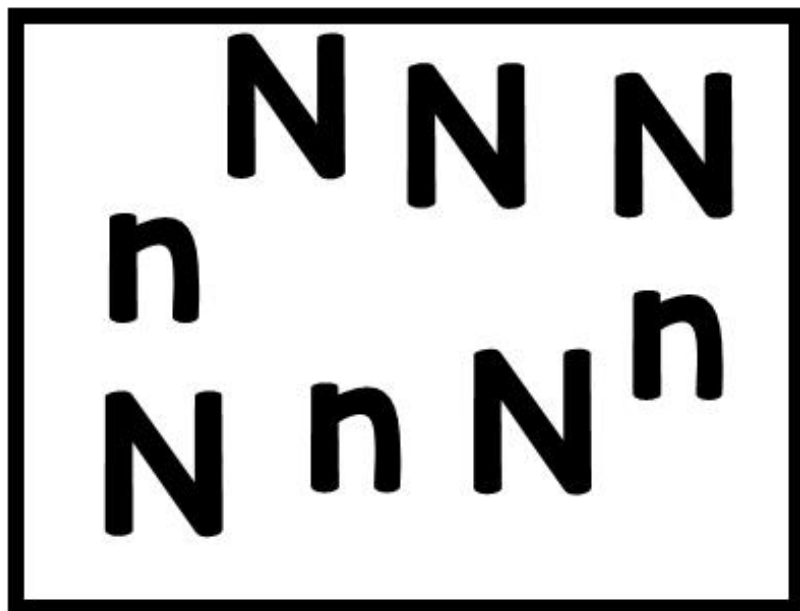

Tally Marks

N

n

Color the
letter there
are more of.

Nn

N

n

1	2	3	4	5
1	2	3	4	5

Name: _____

Write The Letter

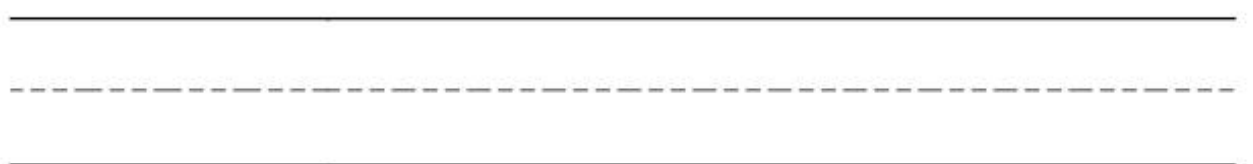
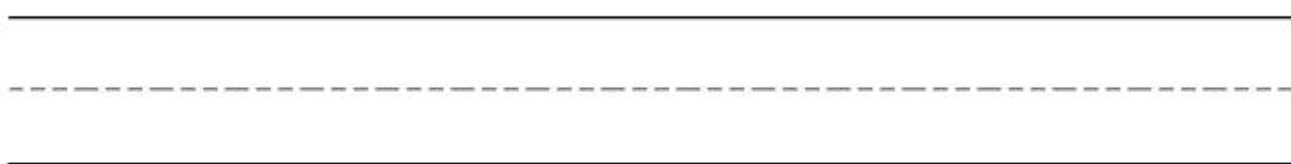
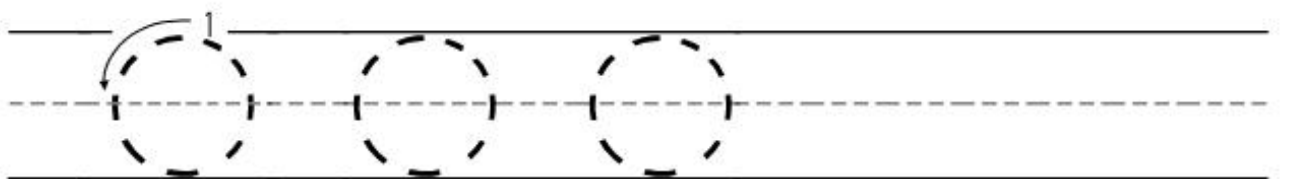
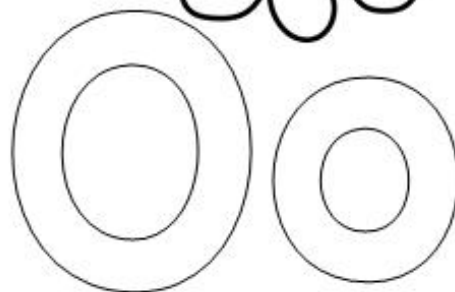
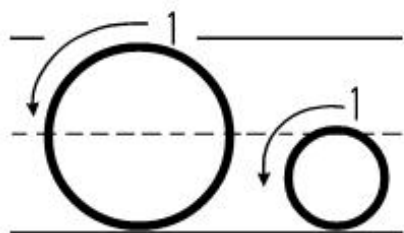

Name: _____

Write The Letter

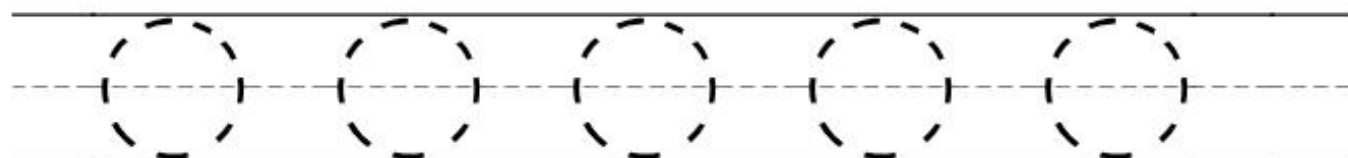
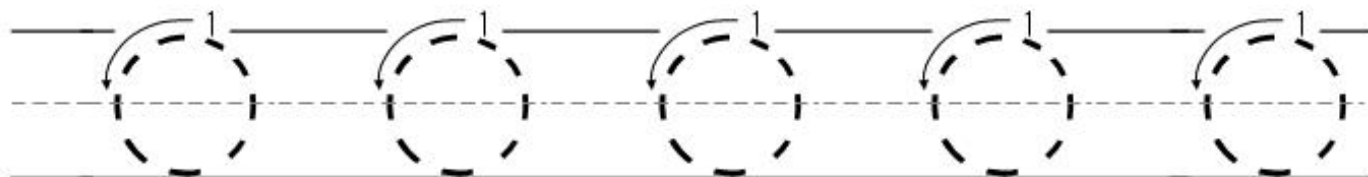
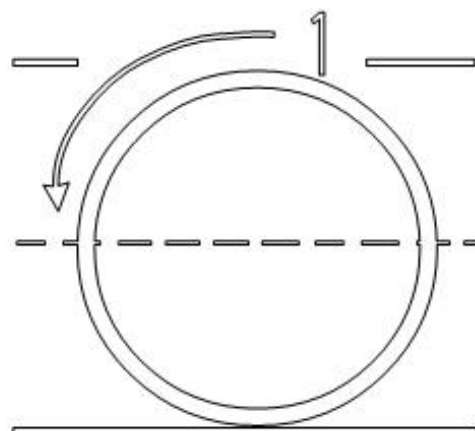
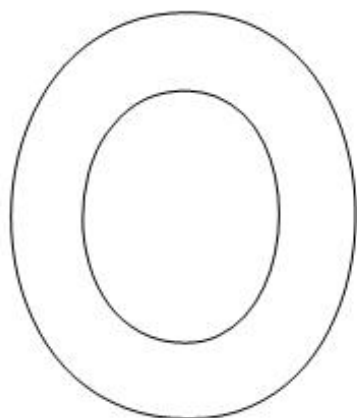

Name: _____

Find and Color

Color the pictures that begin with the letter O

Oo

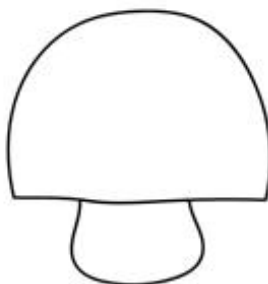
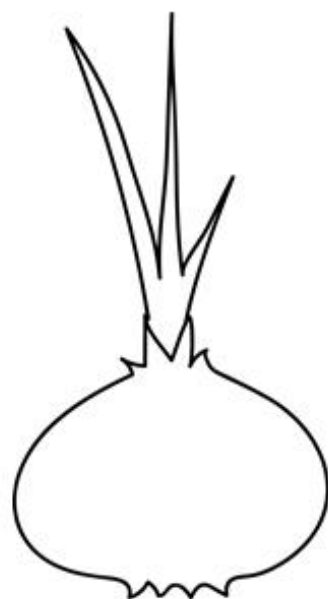
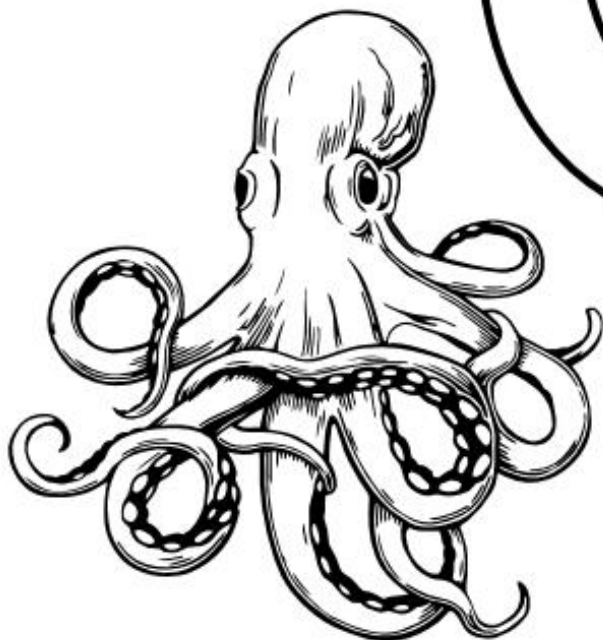
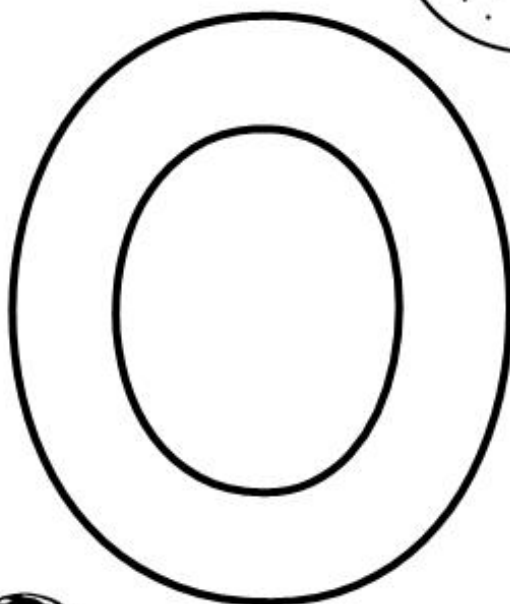
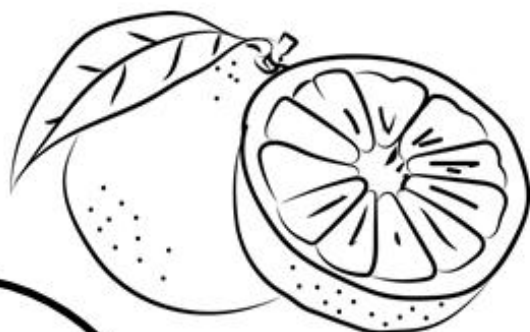
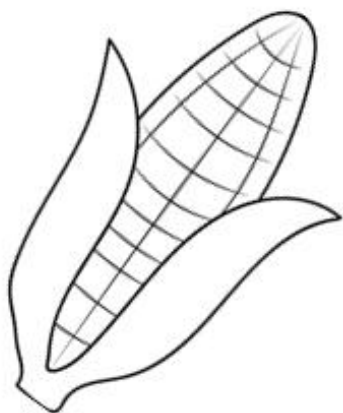

Name: -----

Letter Puzzles

Build the Upper and
Lower Case Puzzles

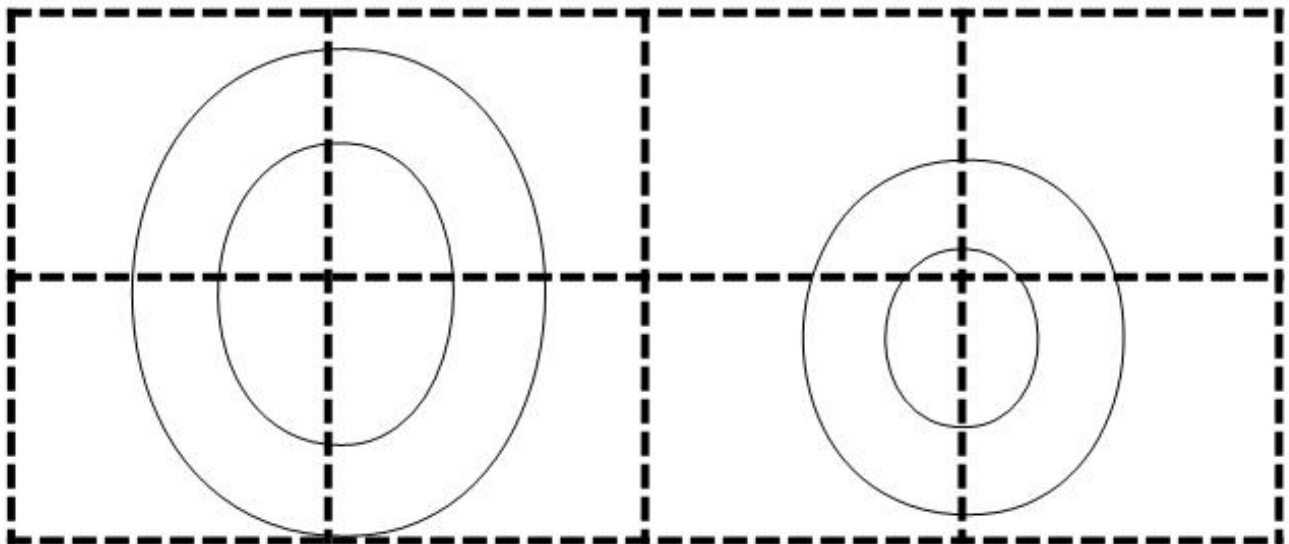
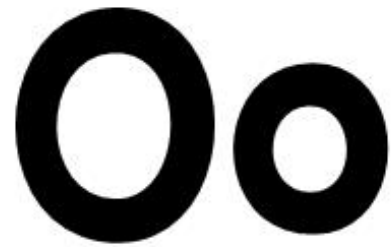

Name: _____

Letter Sorting

Sort the upper and lower case letters.



Upper

Lower

O

o

O

o

O



O

o

Name: _____

Graph The Letter

Count the letters and
fill in the charts.

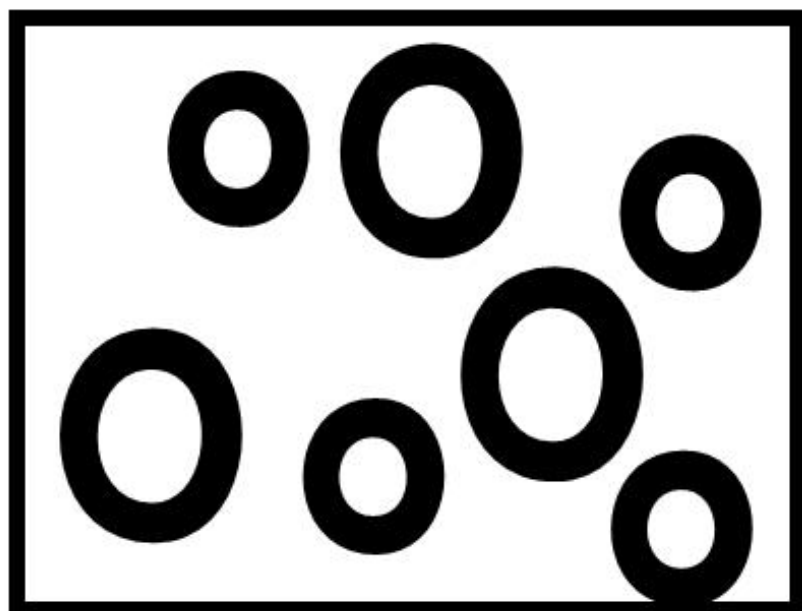

Tally Marks



Color the
letter there
are more of.

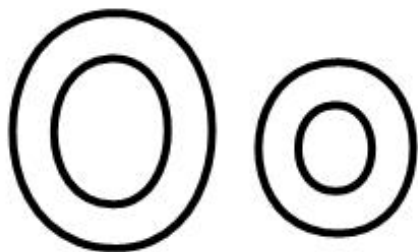

1	2	3	4	5
1	2	3	4	5

Name: _____

Write The Letter

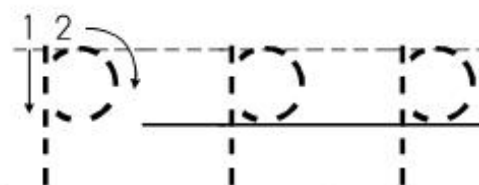
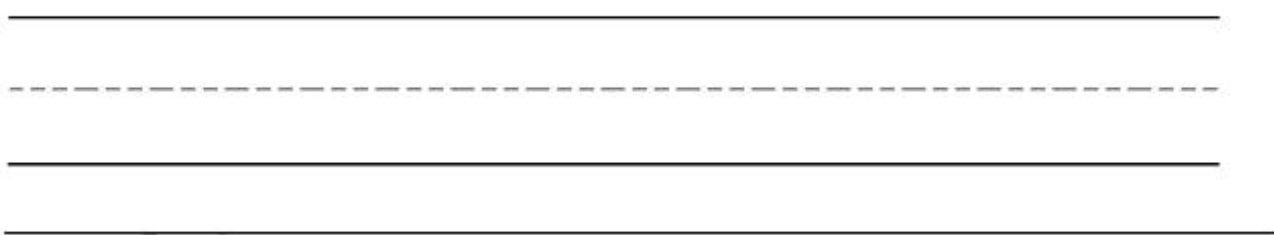
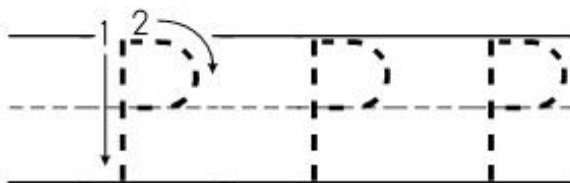
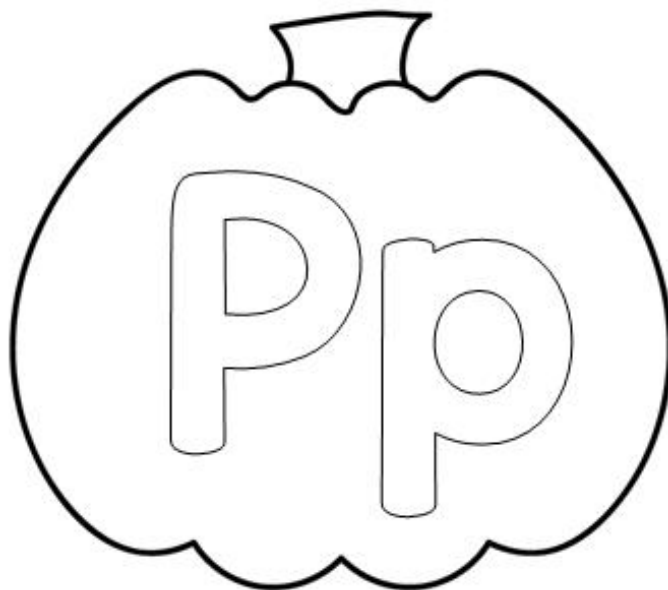
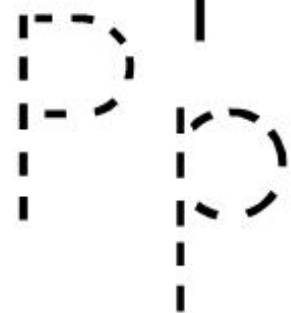
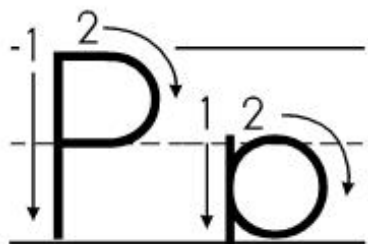

Name: _____

Write The Letter

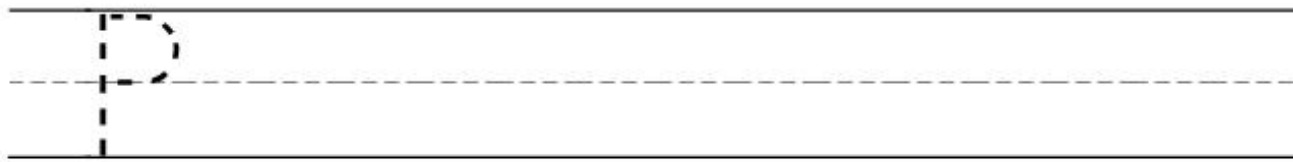
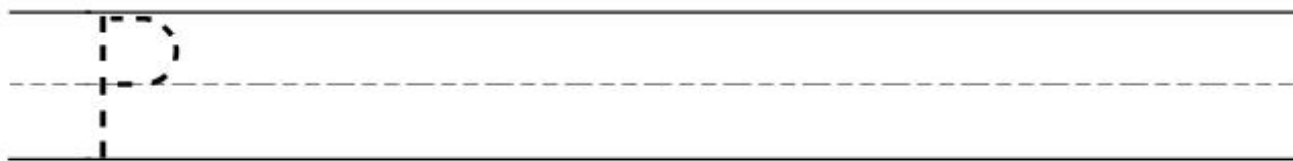
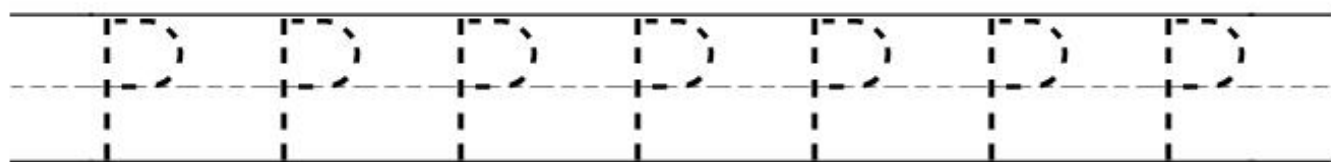
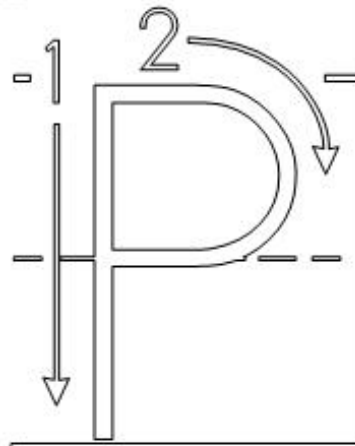
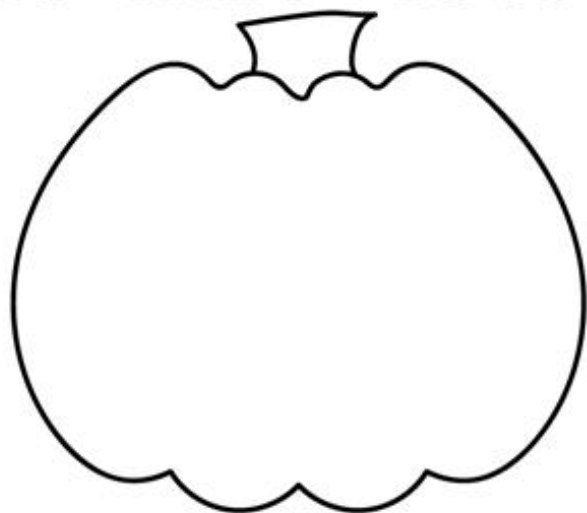
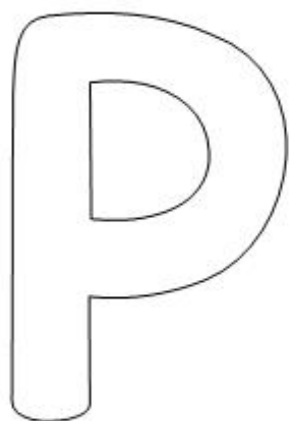

Name: _____

Find and Color

Color the pictures that begin with the letter P

Pp

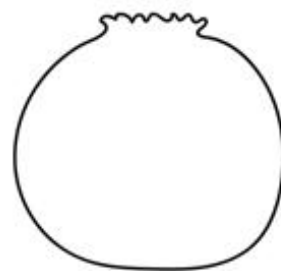
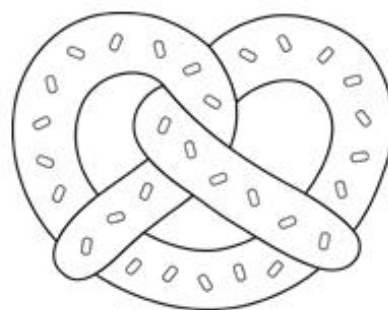
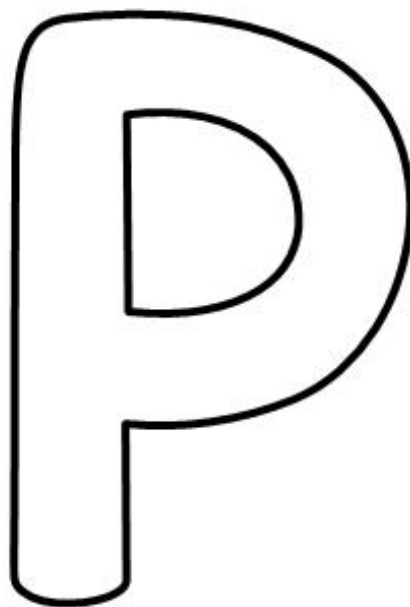
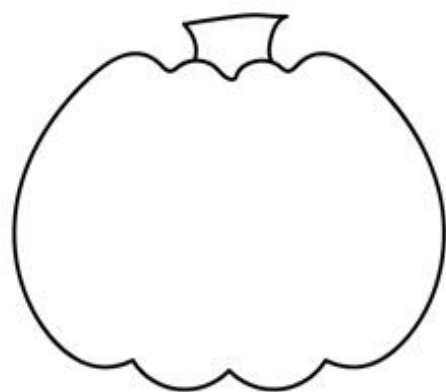
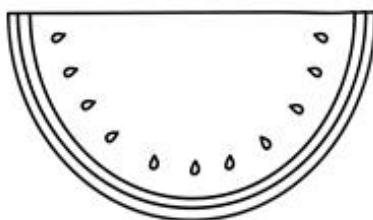

Name: -----

Letter Puzzles

Build the Upper and
Lower Case Puzzles

Pp

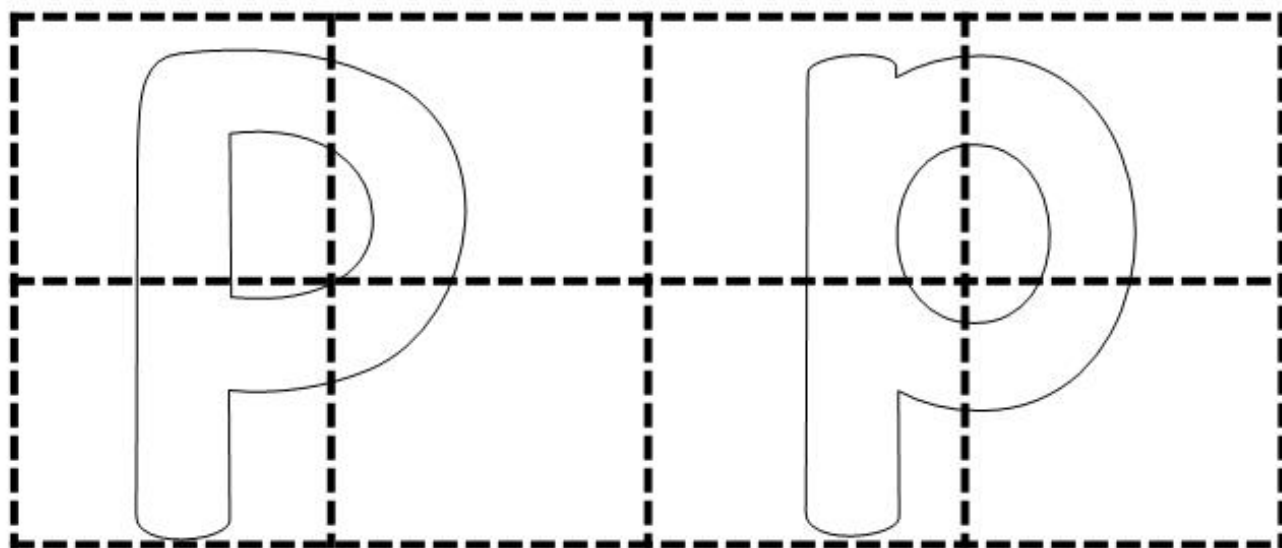

Name: _____

Letter Sorting

Pp

Sort the upper and lower case letters.

Upper

Lower

P

p

p

p

P

P

p

p

Name: _____

Graph The Letter

Count the letters and fill in the charts.

Pp

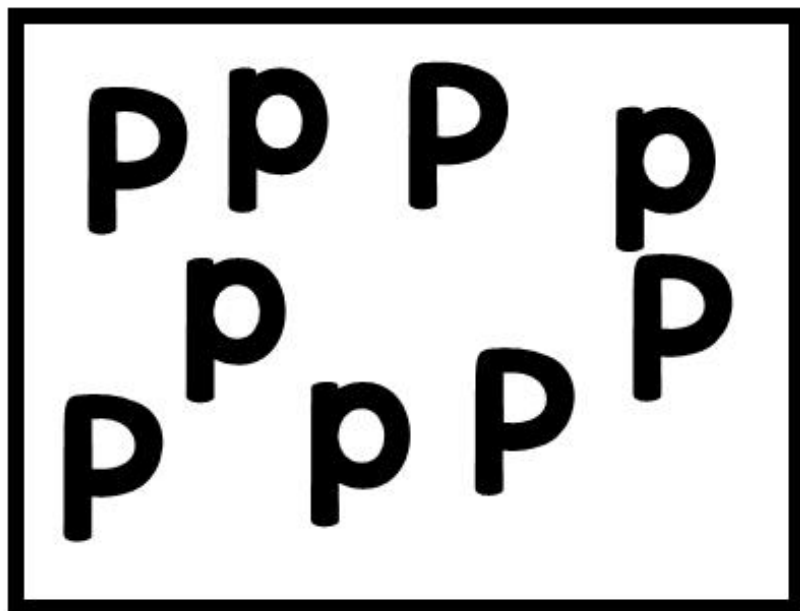

Tally Marks

Color the letter there are more of.

Pp

P

p

1	2	3	4	5
1	2	3	4	5

Name: _____

Write The Letter

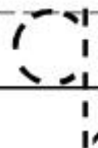
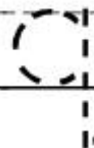
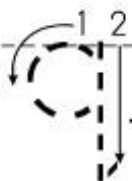
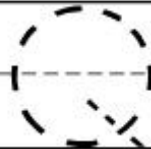
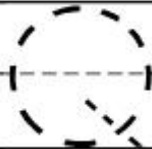
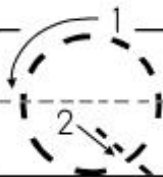
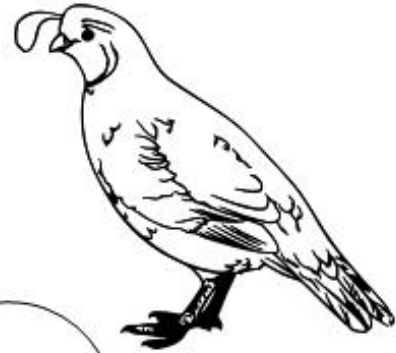
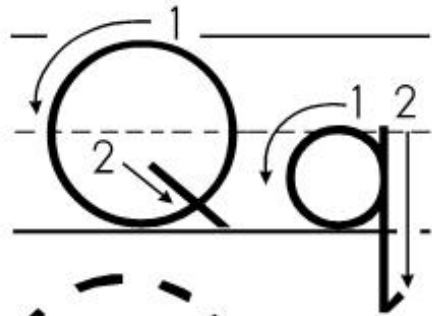

Name: _____

Write The Letter

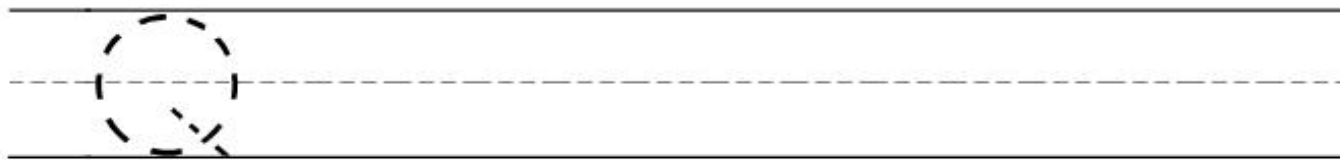
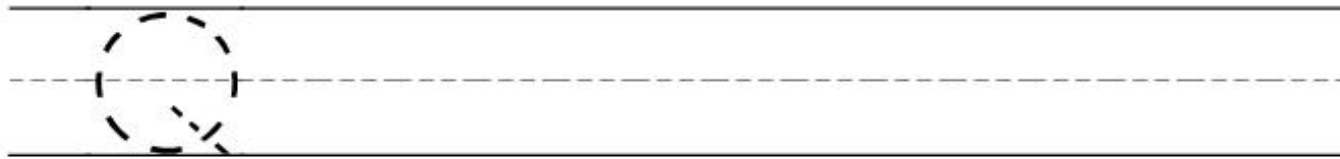
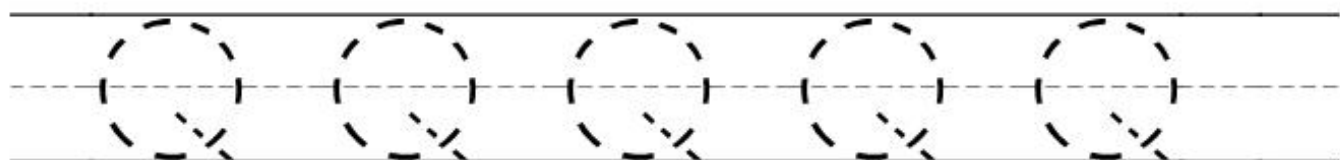
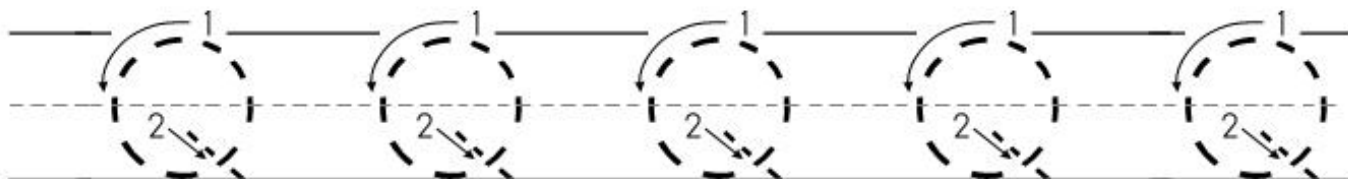
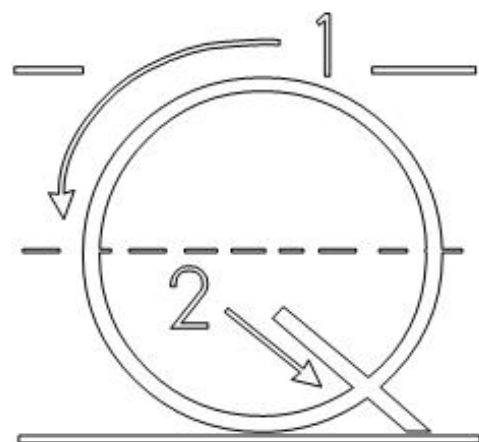
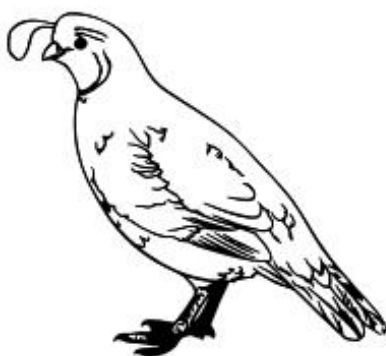
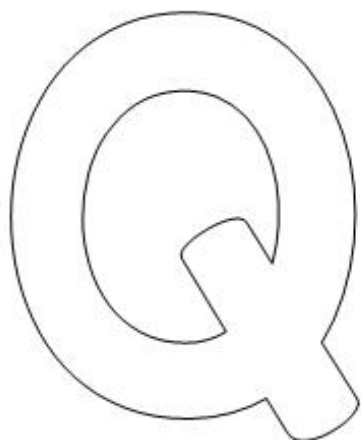

Name: _____

Find and Color

Color the pictures that begin with the letter Q

Qq

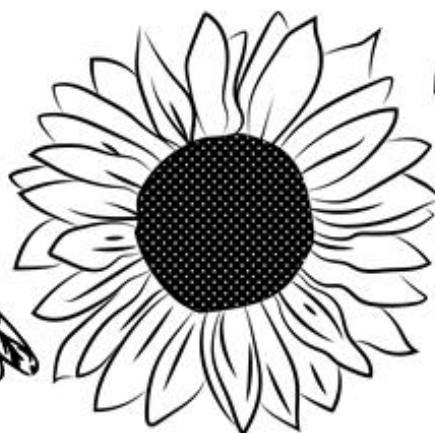
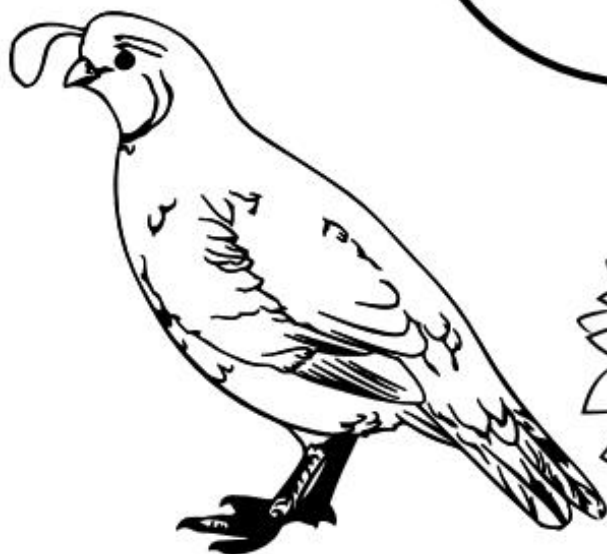
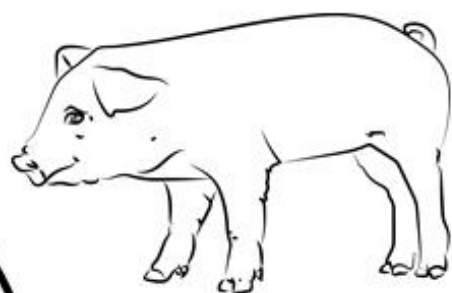

Name: -----

Letter Puzzles

Build the Upper and
Lower Case Puzzles

Qq

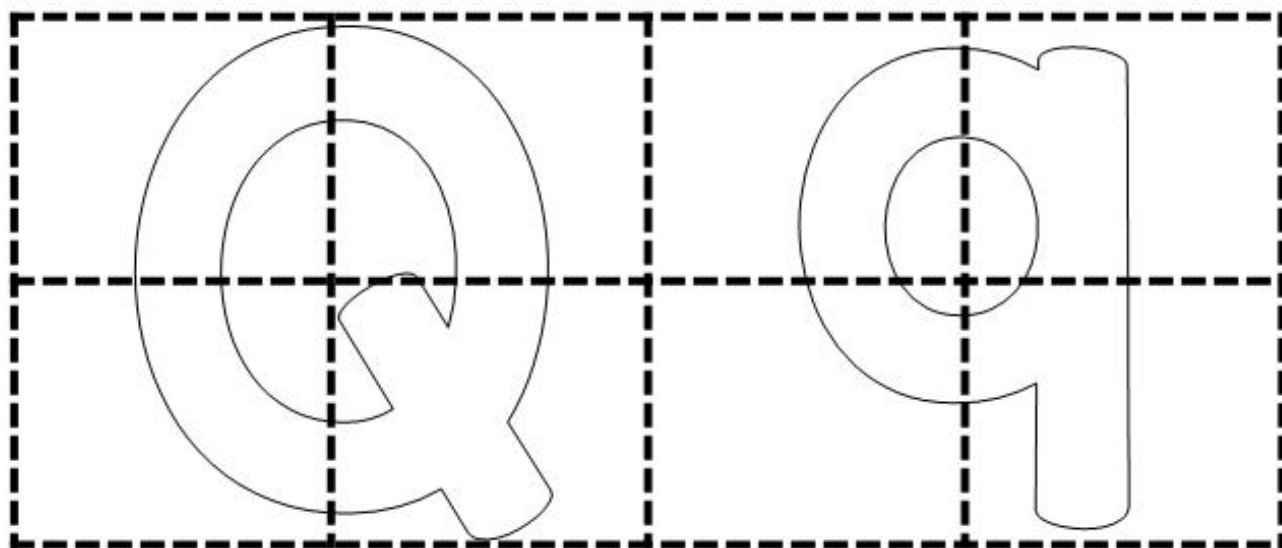

Name: _____

Letter Sorting

Qq

Sort the upper and lower case letters.

Upper

Lower

Q

q

Q

q

Q

Q

q

q

Name: _____

Graph The Letter

Count the letters and
fill in the charts.

Qq

Tally Marks

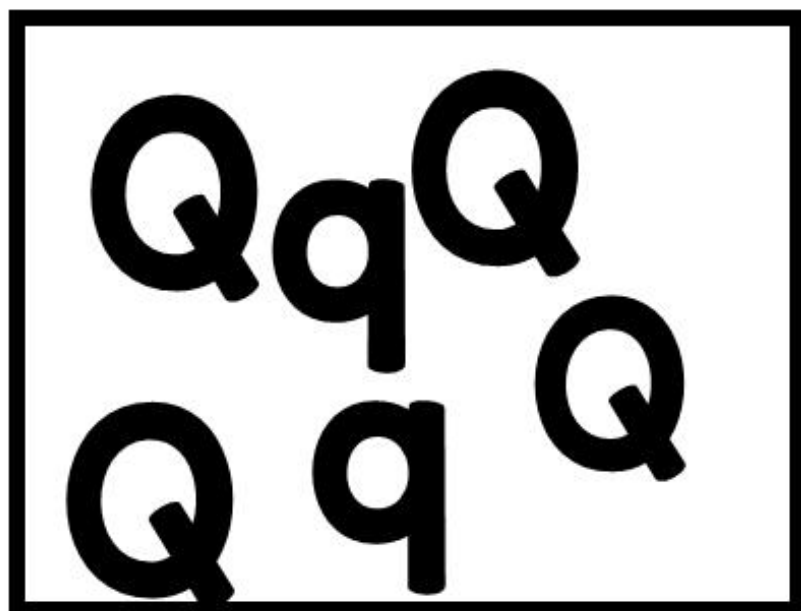

Q

q

Color the
letter there
are more of.

Qq

Q

q

1	2	3	4	5
1	2	3	4	5

Name: _____

Write The Letter

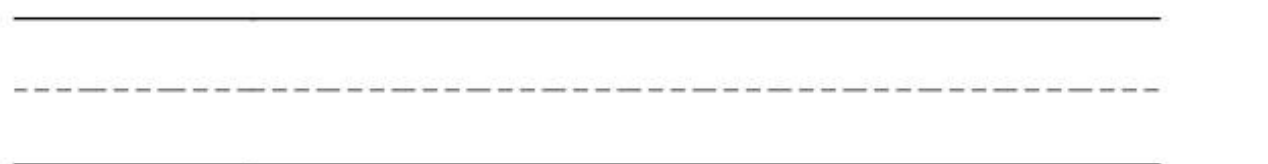
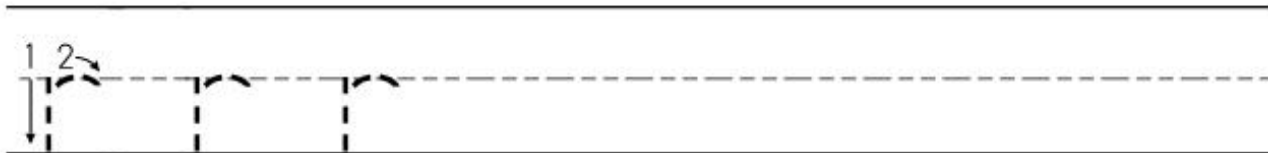
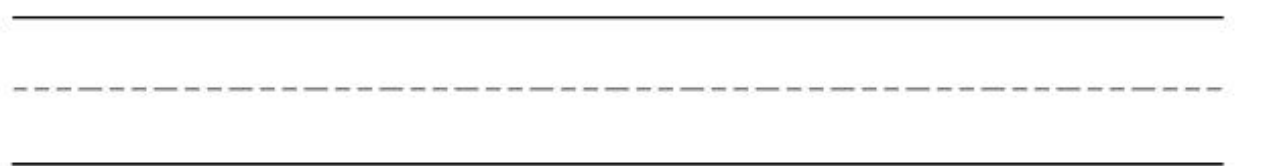
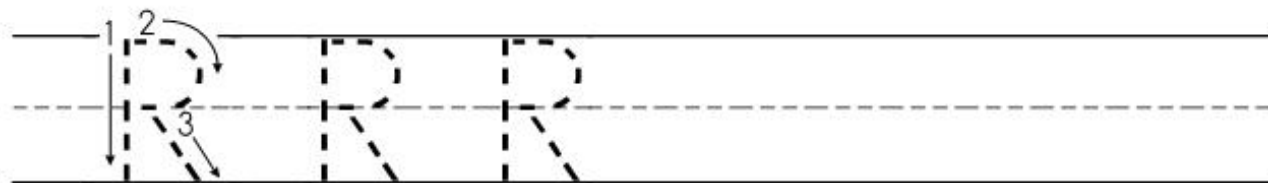
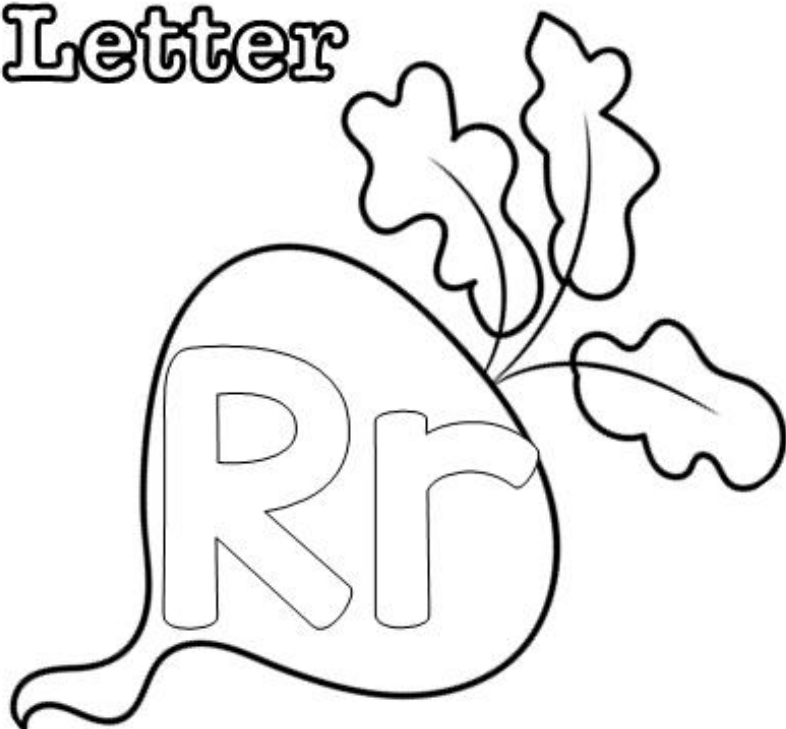
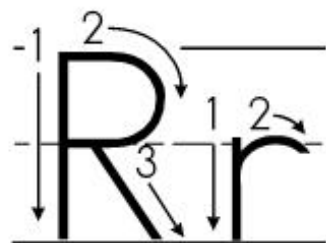

Name: _____

Write The Letter

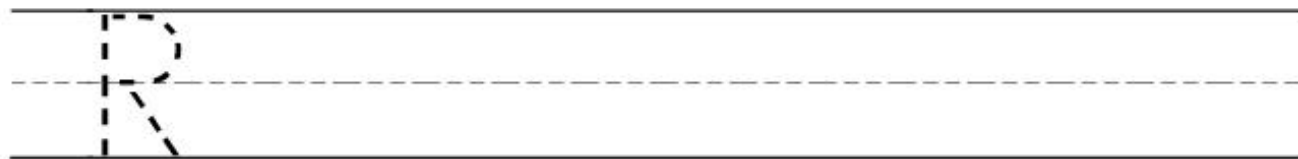
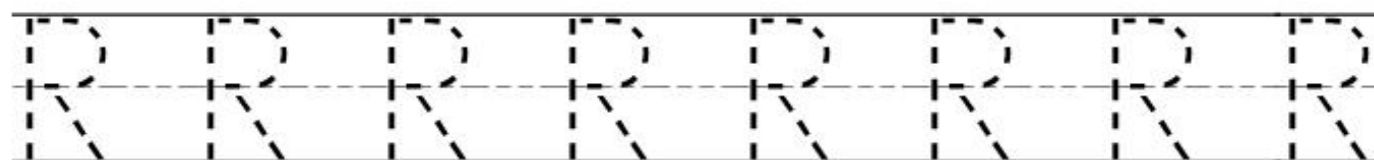
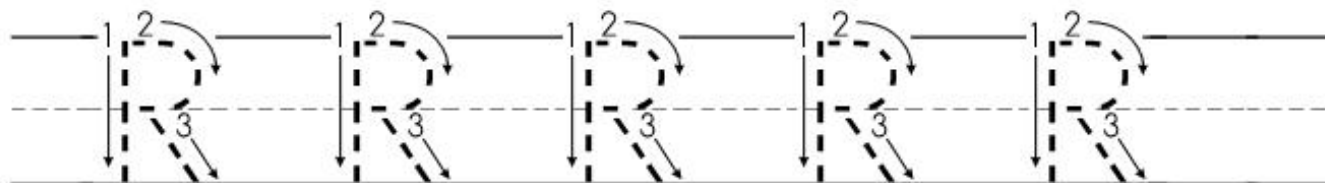
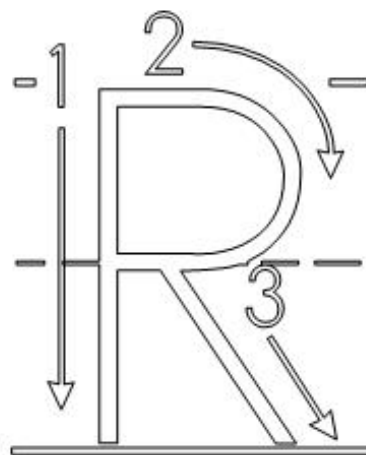
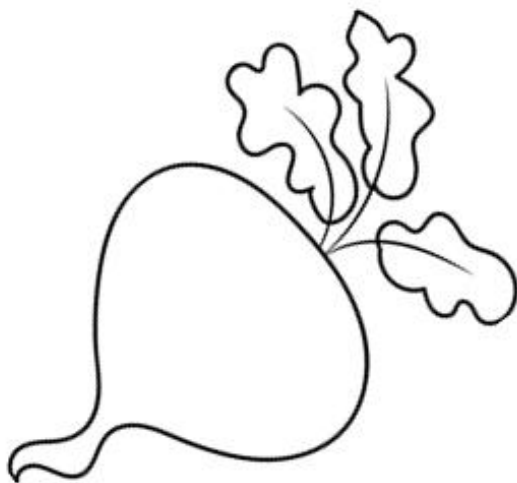
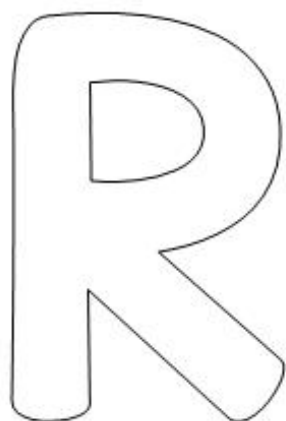

Name: _____

Find and Color

Color the pictures that begin with the letter R

Rr



Name: -----

Letter Puzzles

Build the Upper and
Lower Case Puzzles

Rr

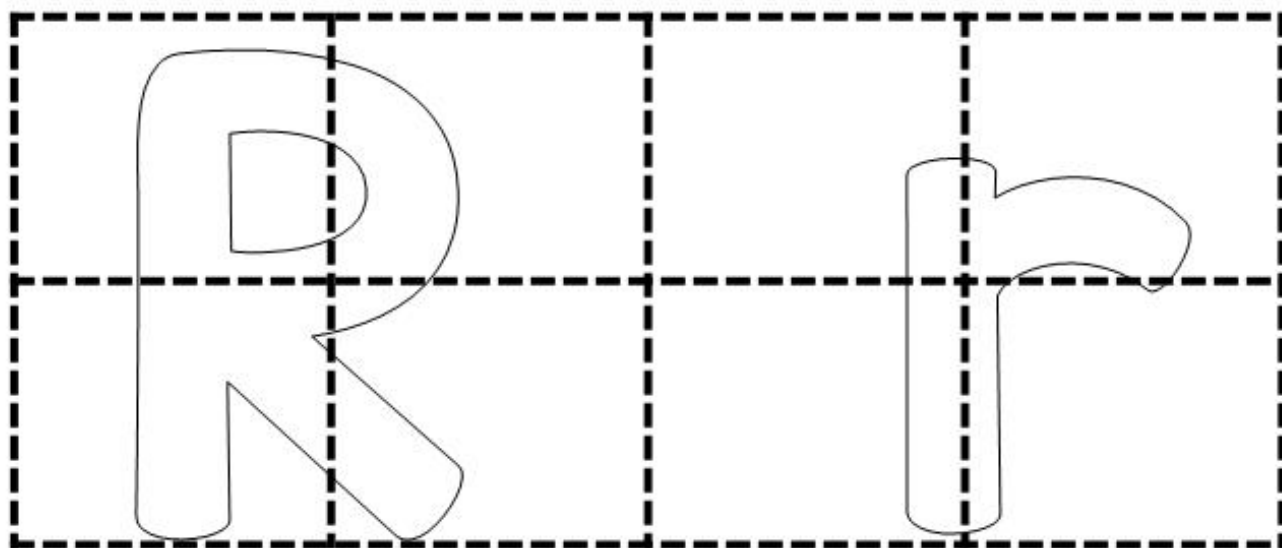

Name: _____

Letter Sorting

Rr

Sort the upper and lower case letters.

Upper

Lower

R

r

R

r

R

R

r

r

Name: _____

Graph The Letter

Count the letters and
fill in the charts.

Rr



Tally Marks

Color the
letter there
are more of.

Rr

R

r

1	2	3	4	5
1	2	3	4	5

Name: _____

Write The Letter

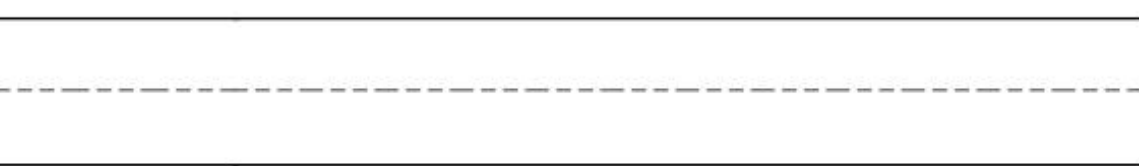
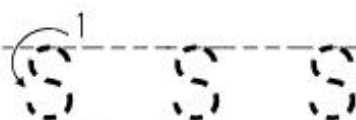
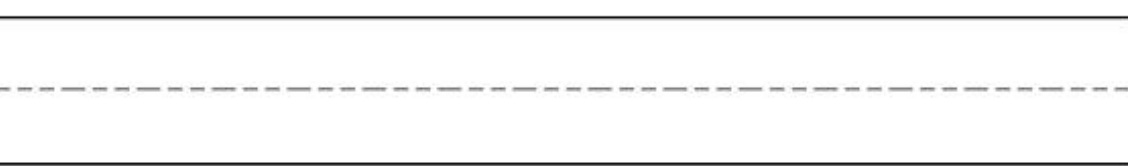
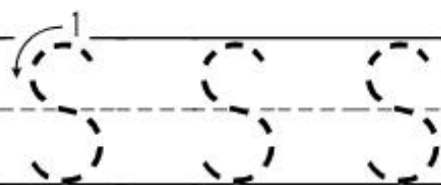
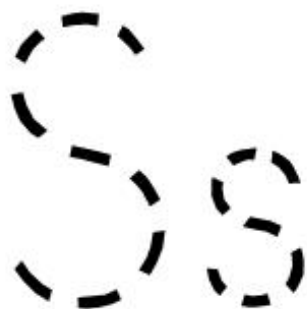
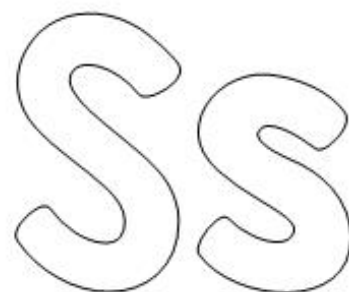
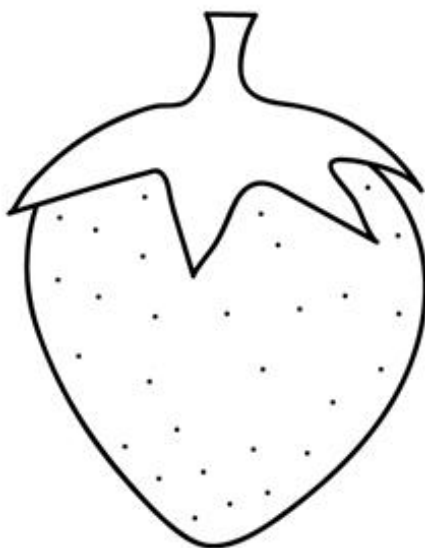
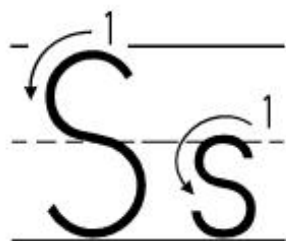

Name: _____

Write The Letter

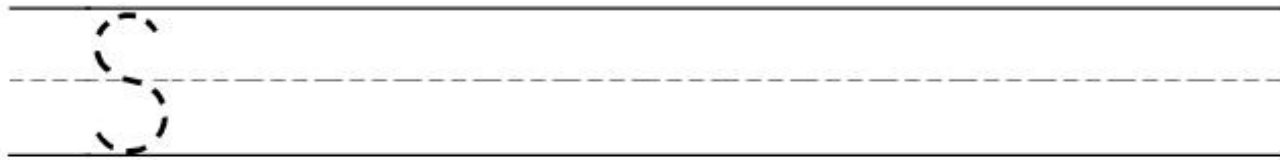
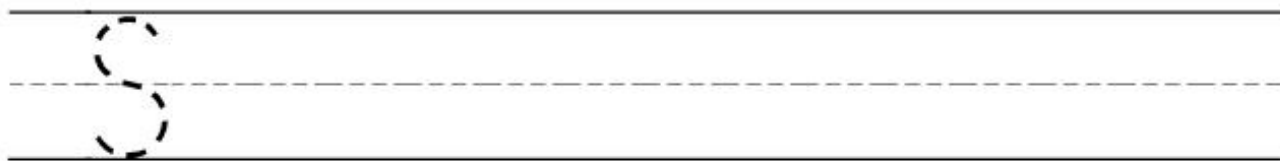
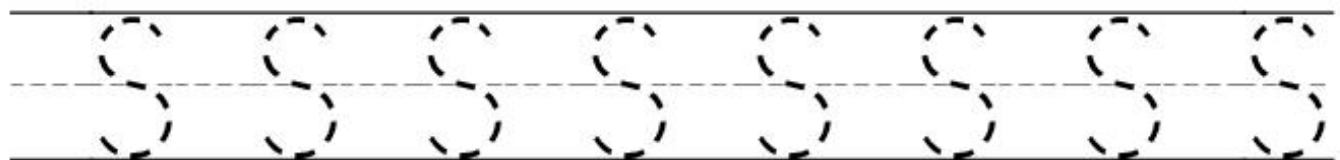
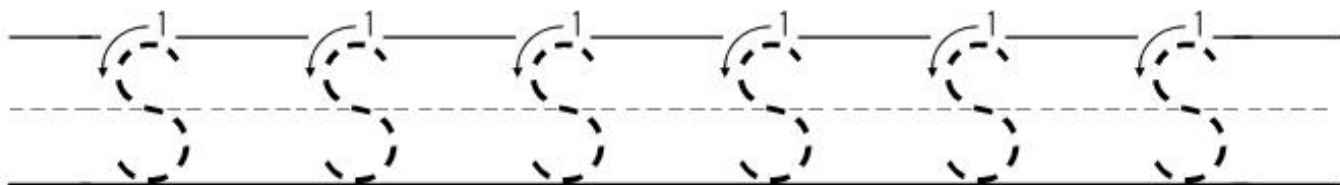
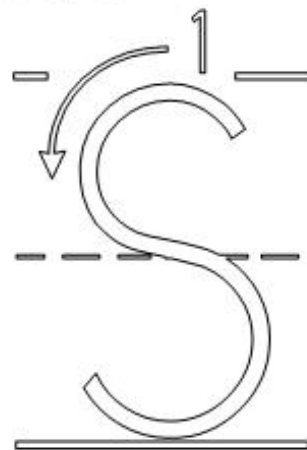
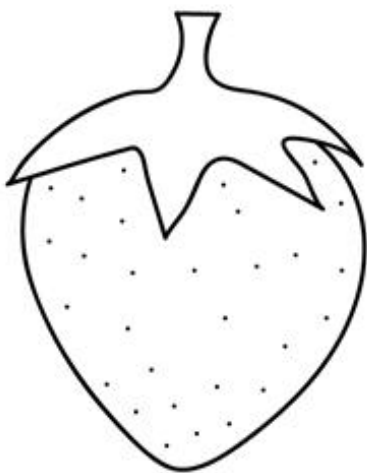
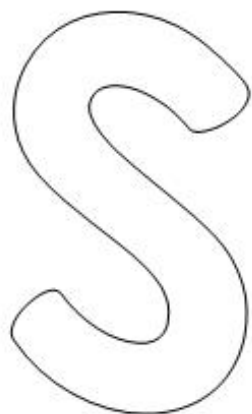

Name: _____

Find and Color

Color the pictures that begin with the letter S

Ss

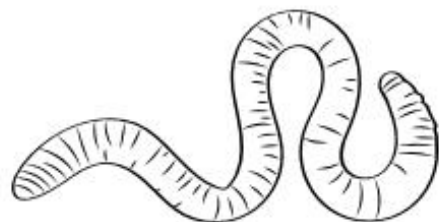
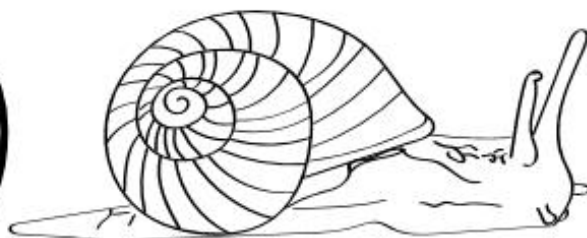
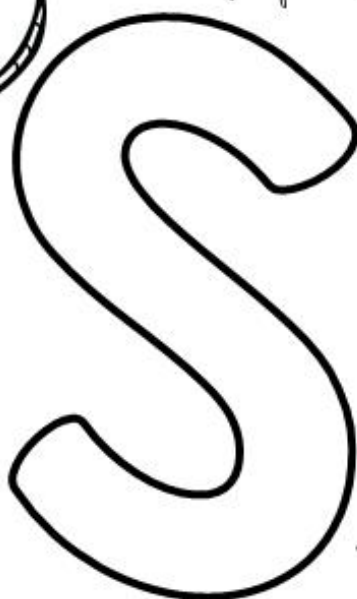
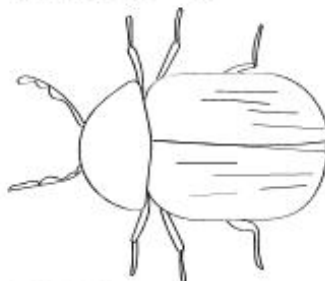
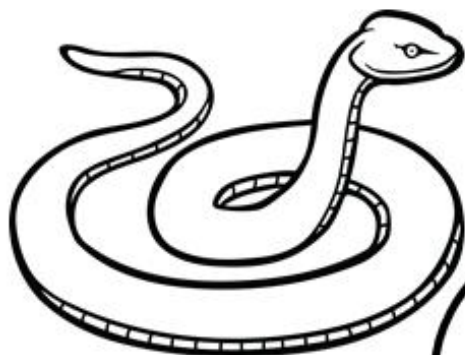

Name: -----

Letter Puzzles

Build the Upper and
Lower Case Puzzles

Ss

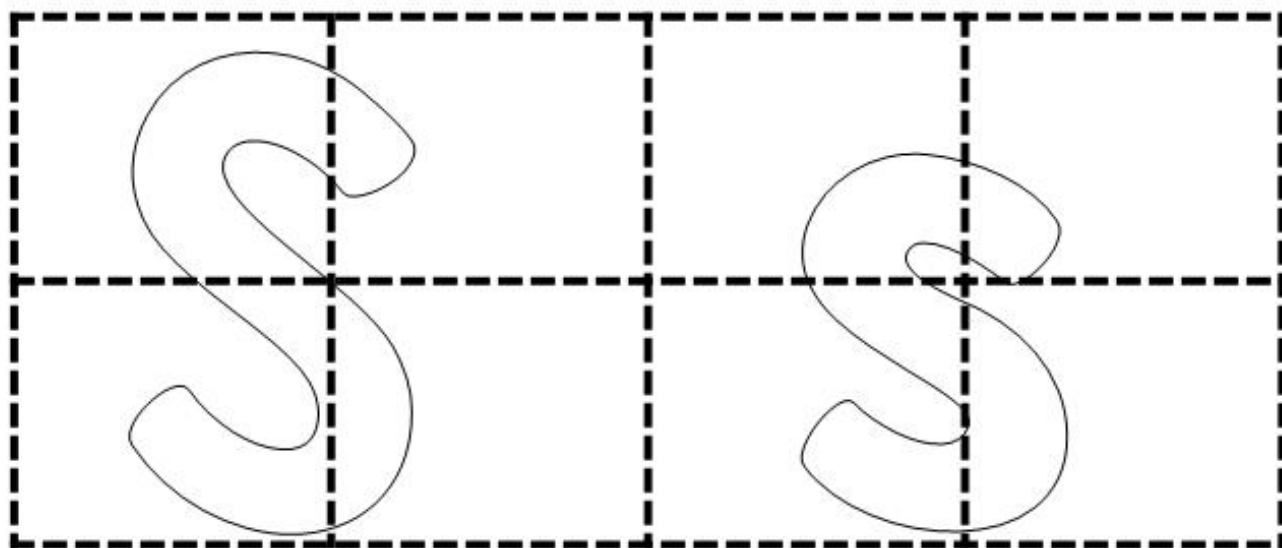

Name: _____

Letter Sorting

Ss

Sort the upper and lower case letters.

Upper

Lower

S

s

S

s

S

S

S

S

Name: _____

Graph The Letter

Count the letters and fill in the charts.

Ss

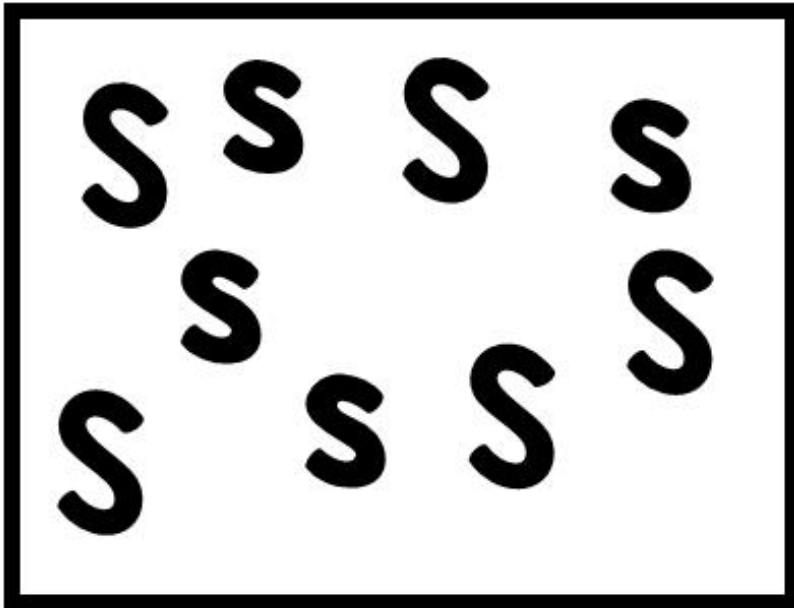

Tally Marks

Color the letter there are more of.

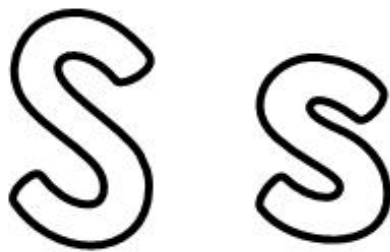

1	2	3	4	5
1	2	3	4	5

Name: _____

Write The Letter

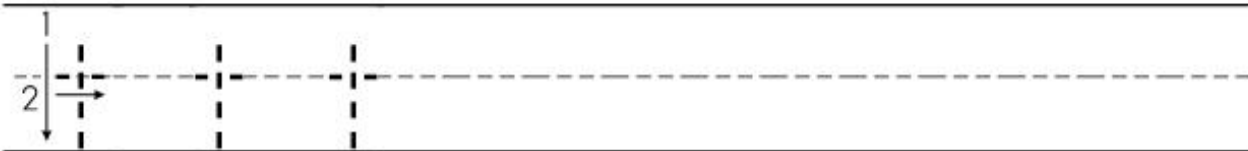
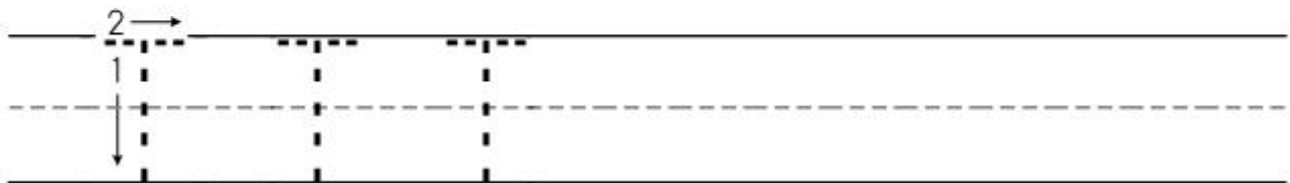
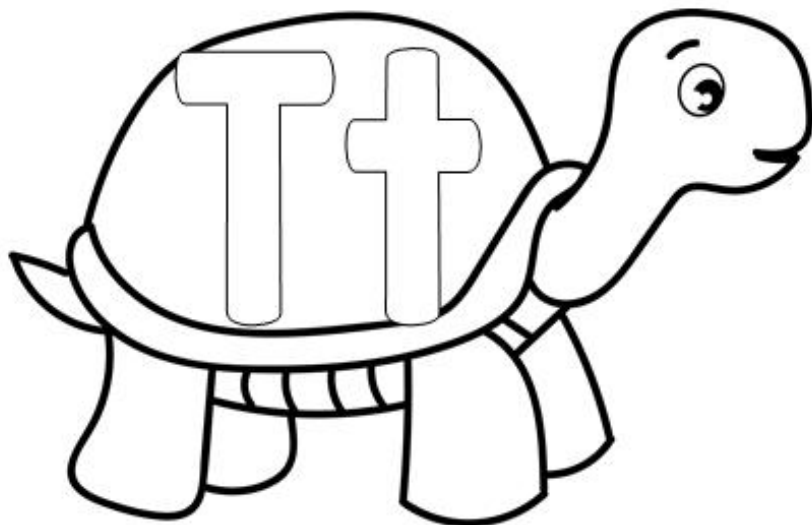
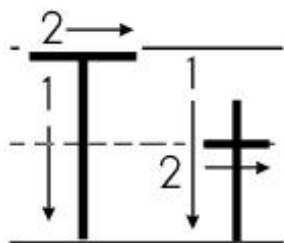

Name: _____

Write The Letter

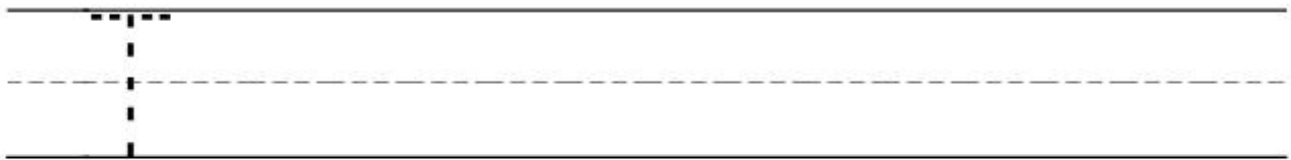
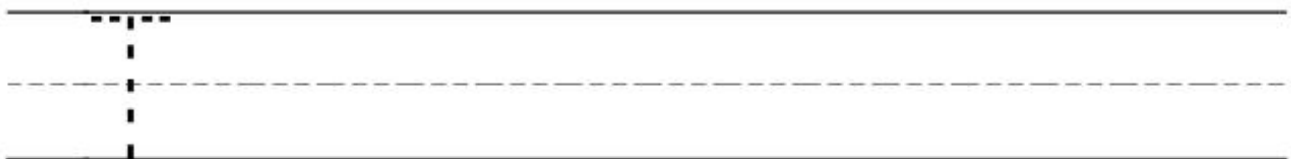
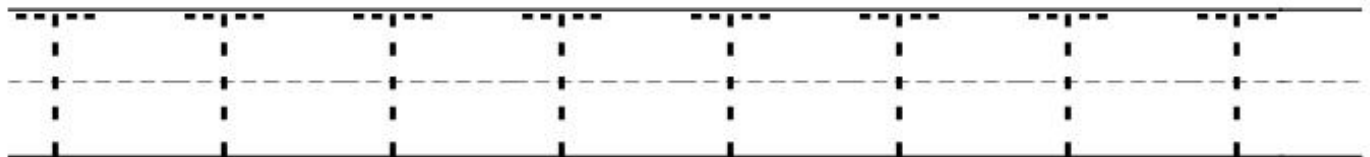
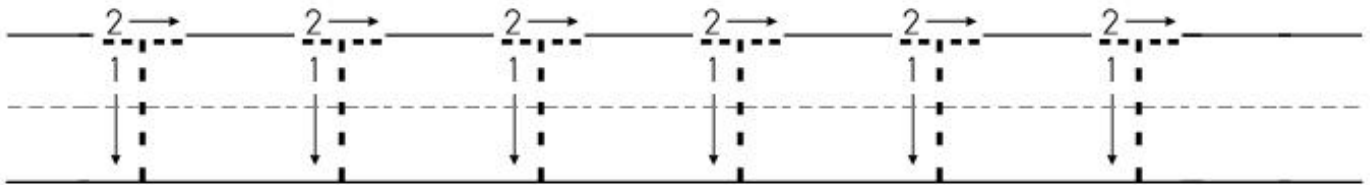
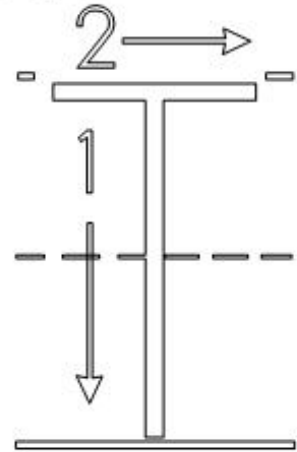
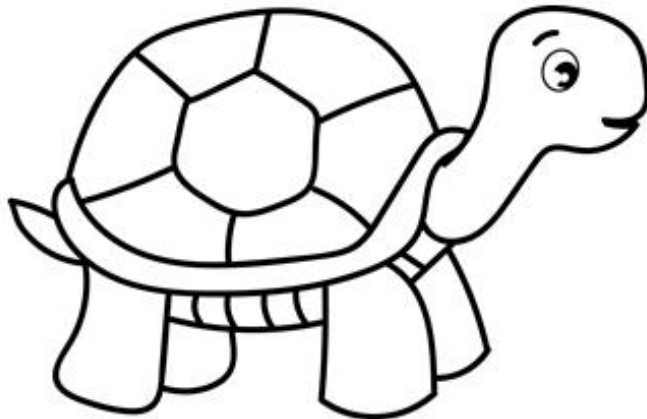
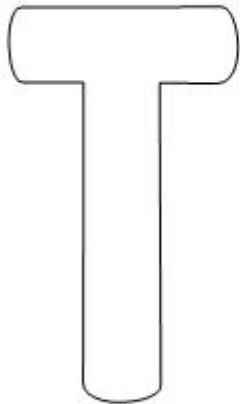

Name: _____

Find and Color

Color the pictures that begin with the letter T

Tt

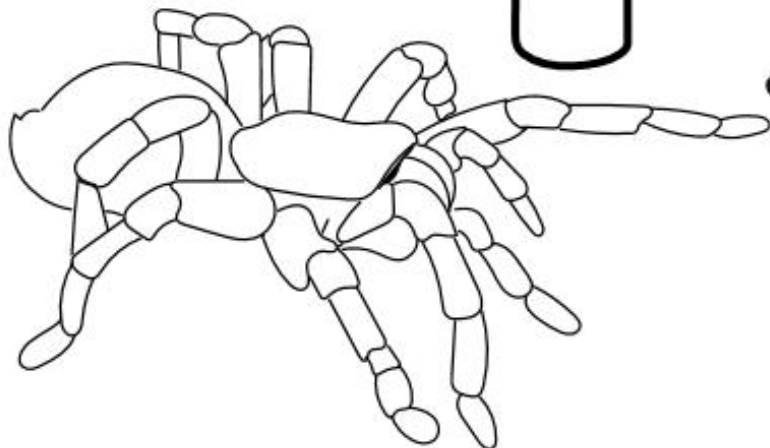
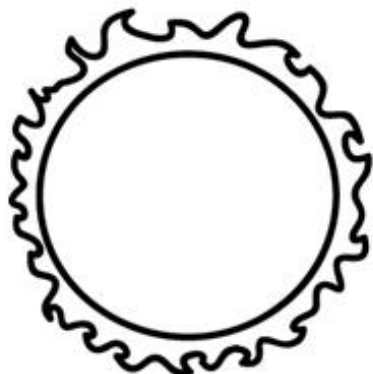
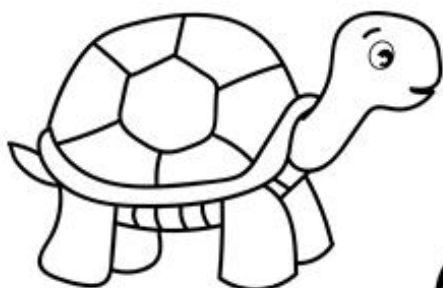

Name: -----

Letter Puzzles



Build the Upper and
Lower Case Puzzles

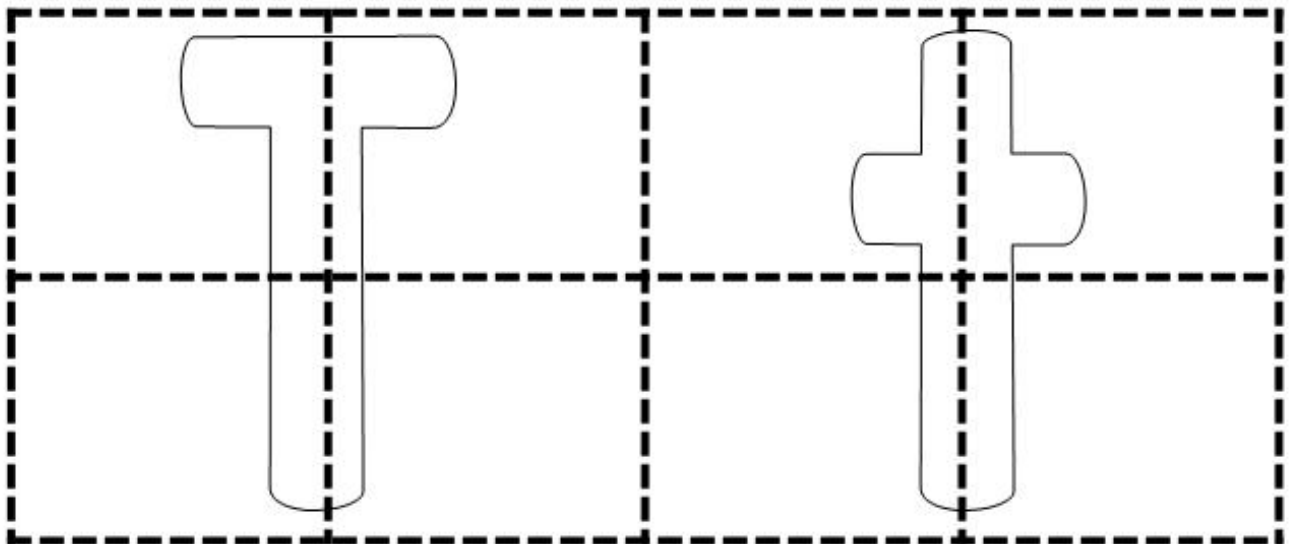

Name: _____

Letter Sorting

Tt

Sort the upper and lower case letters.

Upper

Lower

T

t

T

t

T

T

t

t

Name: _____

Graph The Letter

Count the letters and fill in the charts.

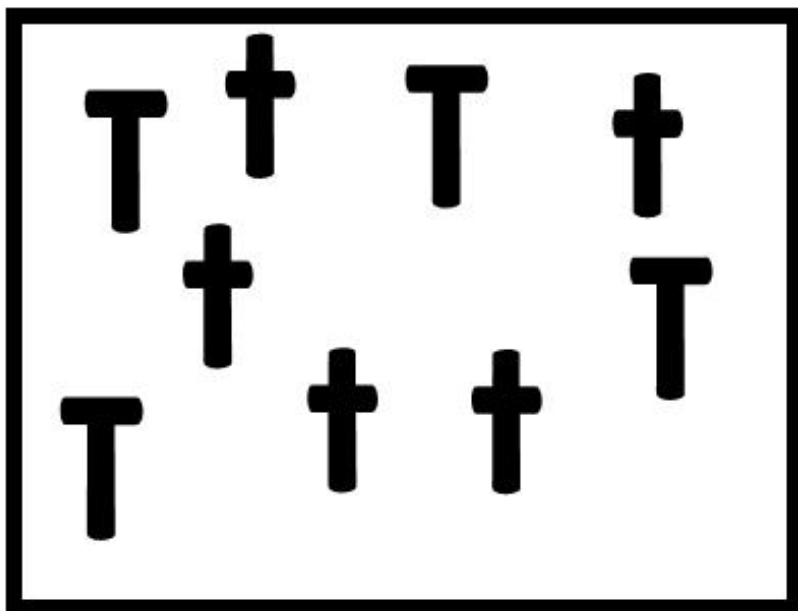

Tally Marks

Color the letter there are more of.

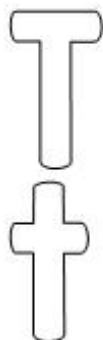
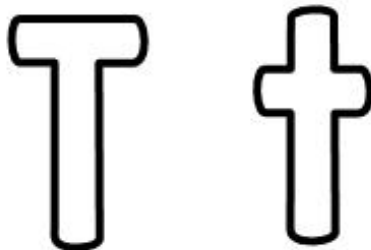

1	2	3	4	5
1	2	3	4	5

Name: _____

Write The Letter

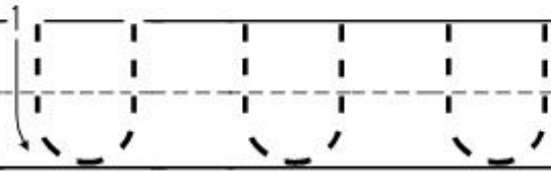
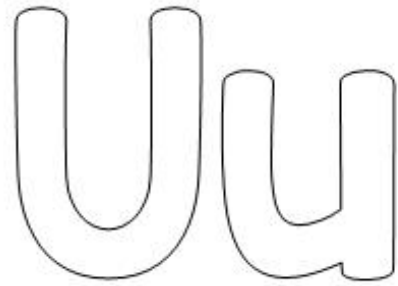
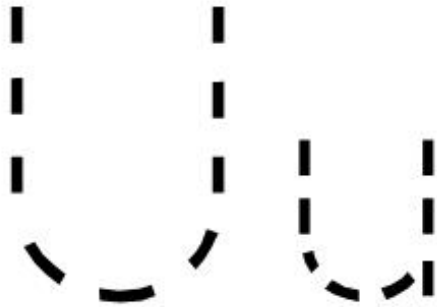
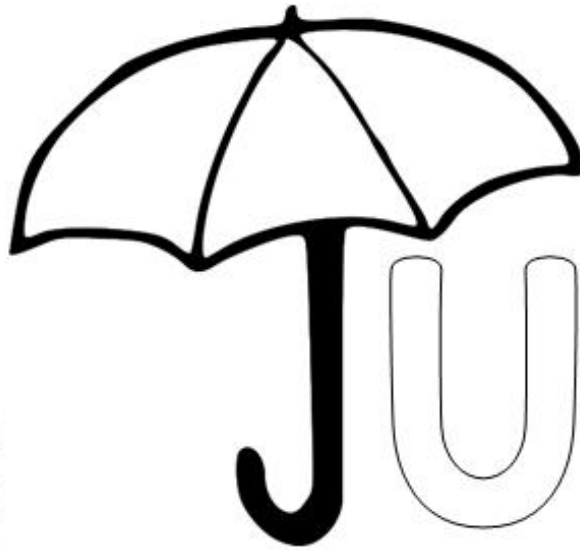
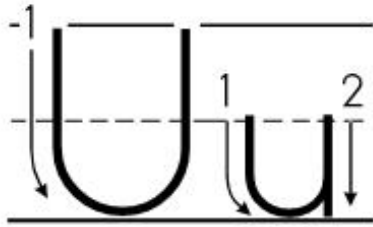

Name: _____

Write The Letter

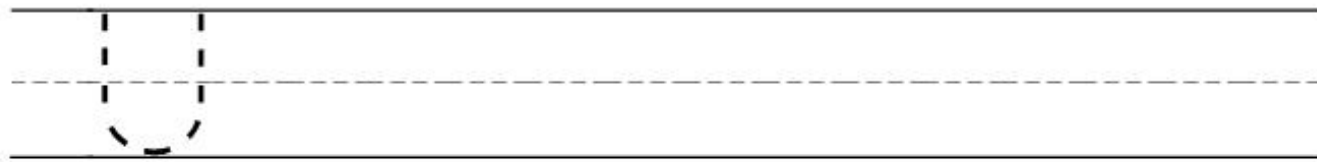
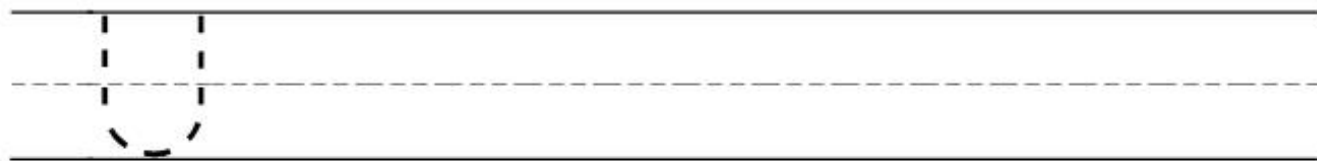
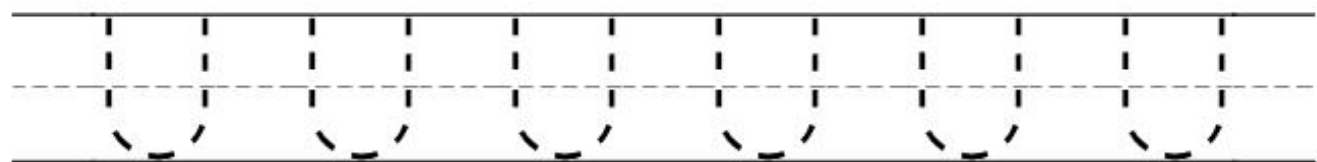
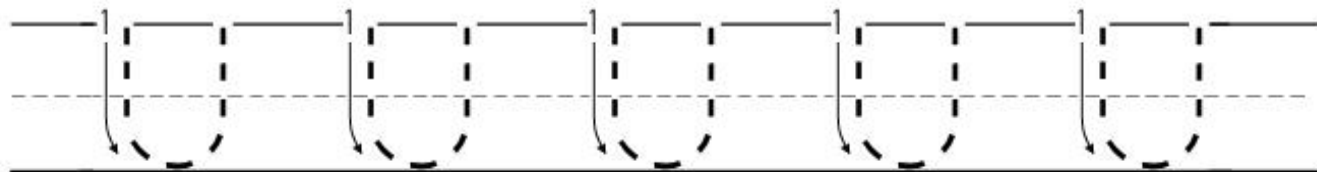
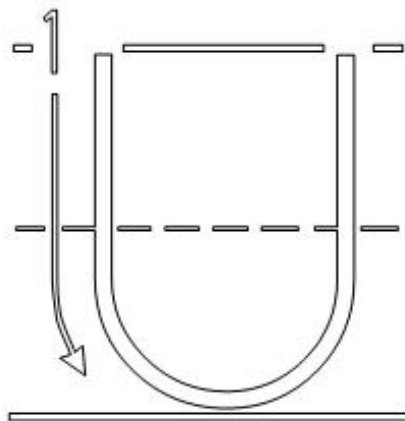
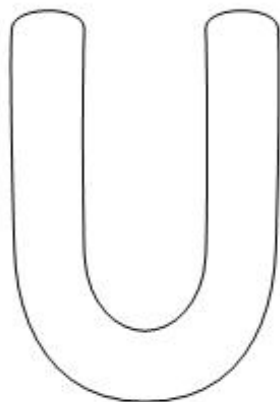

Name: _____

Find and Color

Color the pictures that begin with the letter U

Uu

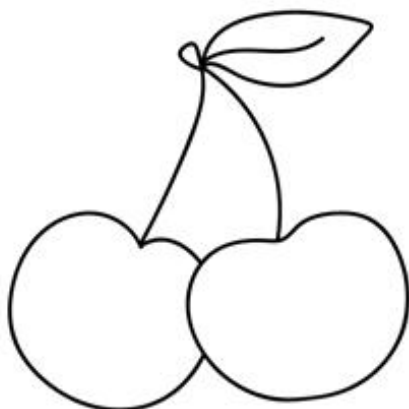
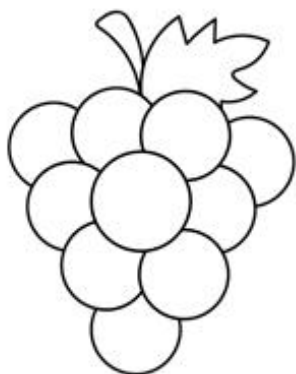
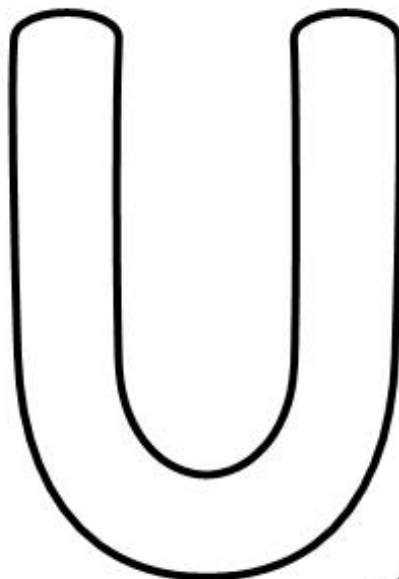

Name: -----

Letter Puzzles

Uu

Build the Upper and
Lower Case Puzzles

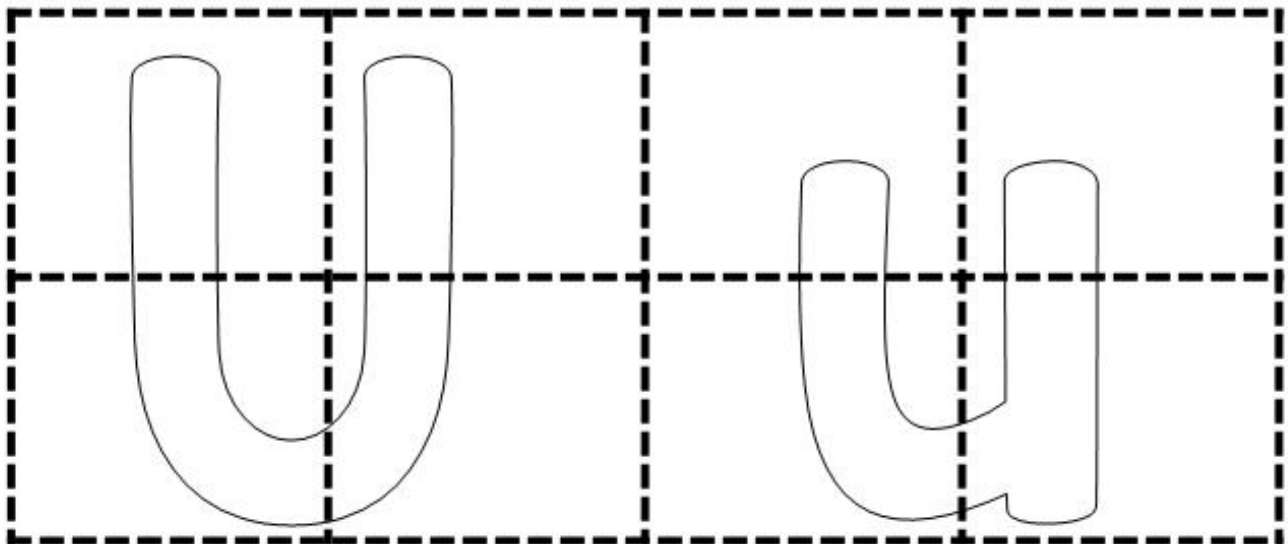

Name: _____

Letter Sorting

Uu

Sort the upper and lower case letters.

Upper

Lower

U

u

U

u

U

U

u

u

Name: _____

Graph The Letter

Count the letters and fill in the charts.

Uu

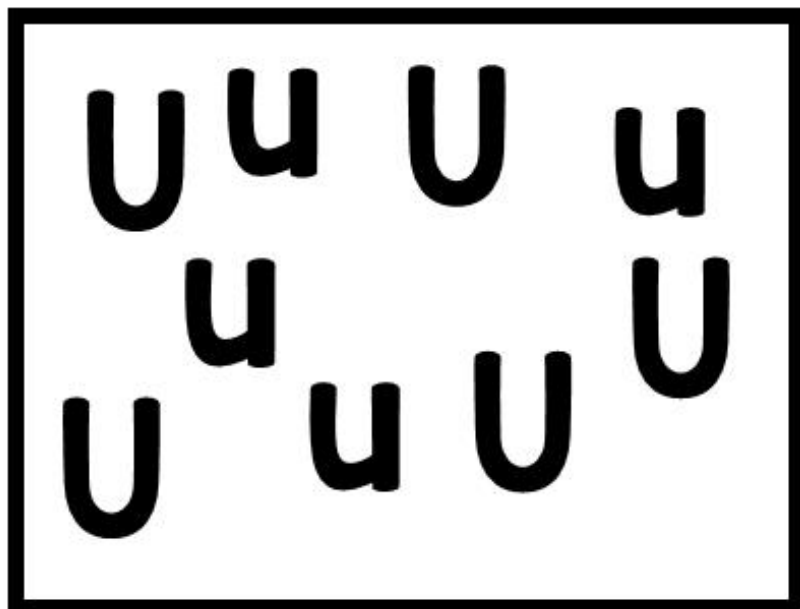

Tally Marks

U
u

Color the letter there are more of.

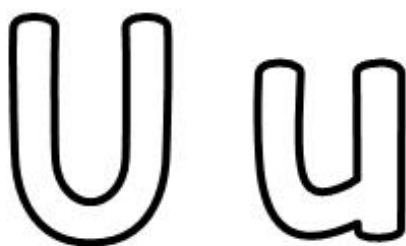

1	2	3	4	5
1	2	3	4	5

Name: _____

Write The Letter

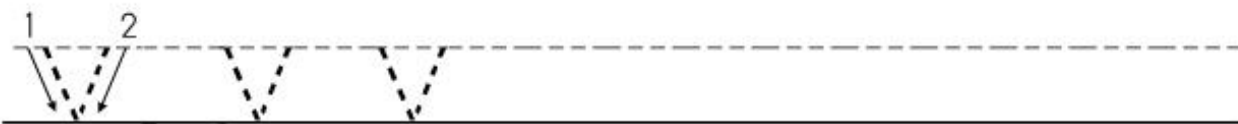
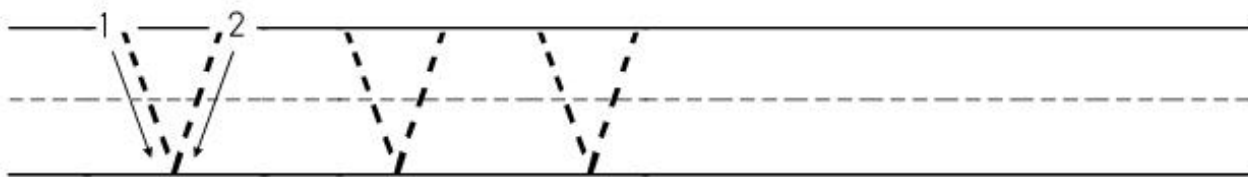
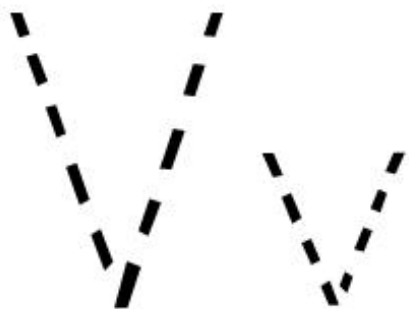
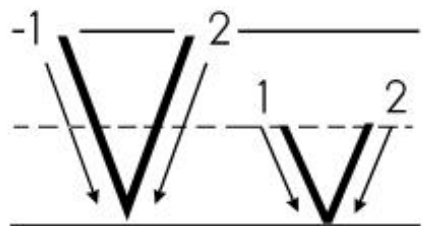

Name: _____

Write The Letter

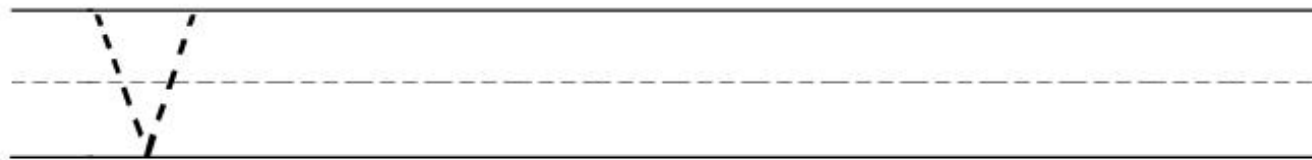
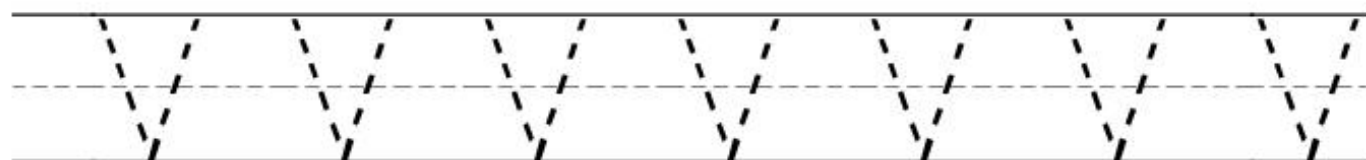
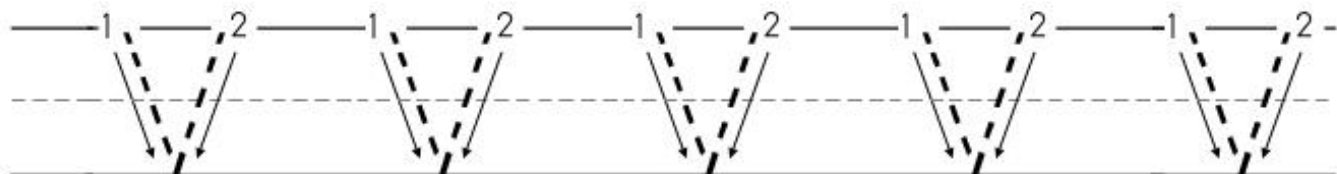
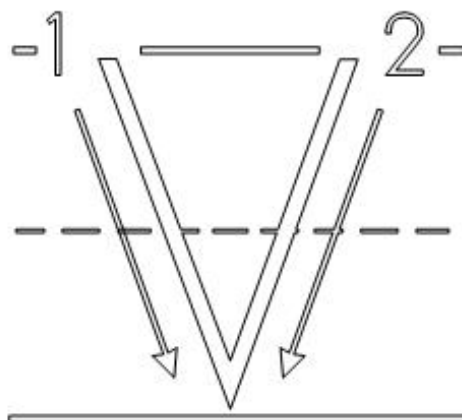
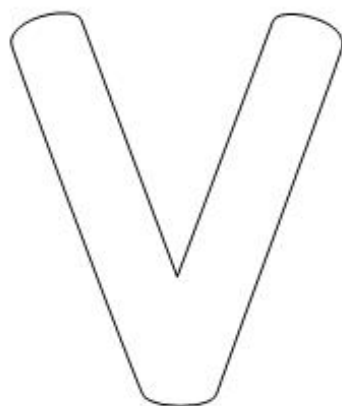

Name: _____

Find and Color

Color the pictures that begin with the letter V

Vv

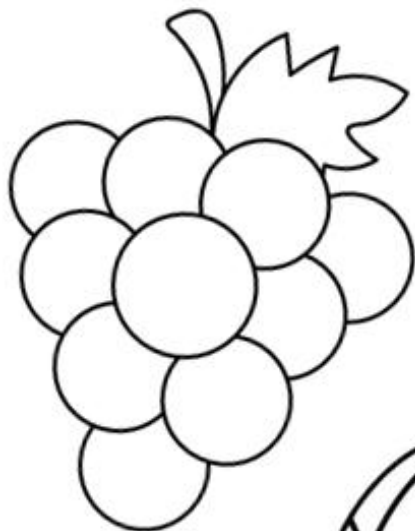
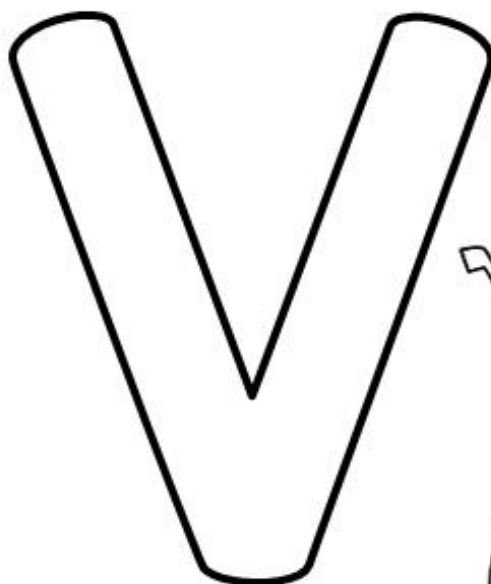

Name: -----

Letter Puzzles



Build the Upper and
Lower Case Puzzles

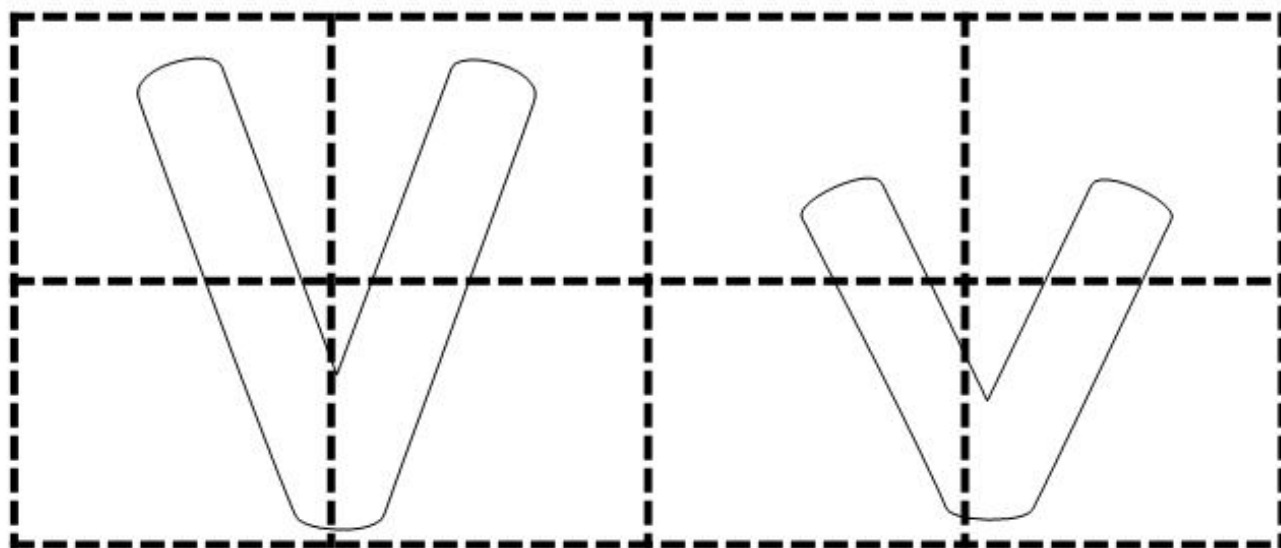

Name: _____

Letter Sorting



Sort the upper and lower case letters.

Upper

Lower

V

v

V

v

V

V

v

v

Name: _____

Graph The Letter

Count the letters and
fill in the charts.

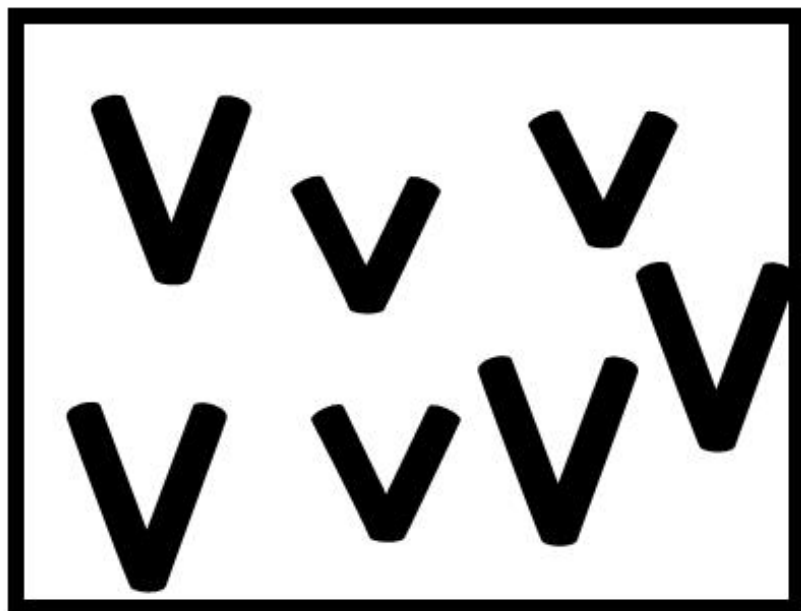

Tally Marks





Color the
letter there
are more of.



1	2	3	4	5
1	2	3	4	5

Name: _____

Write The Letter

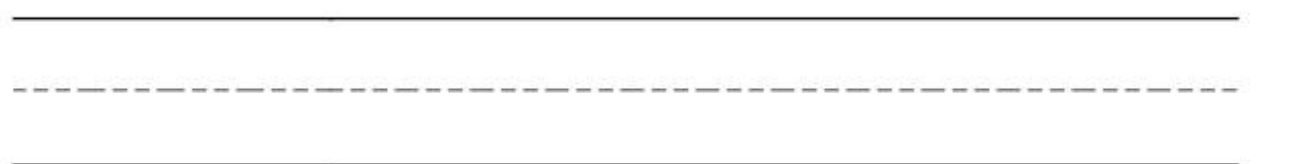
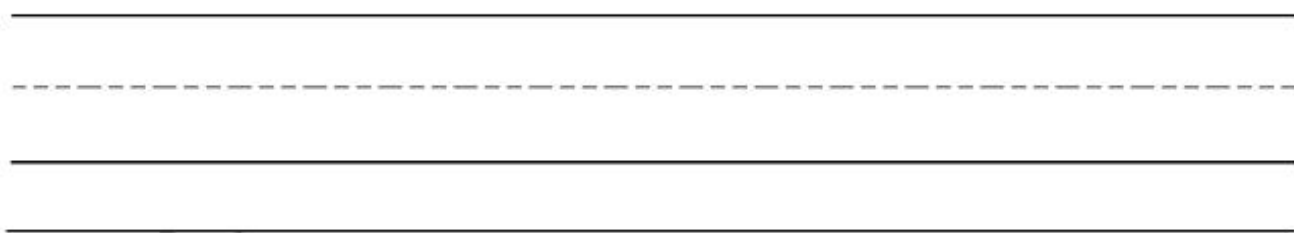
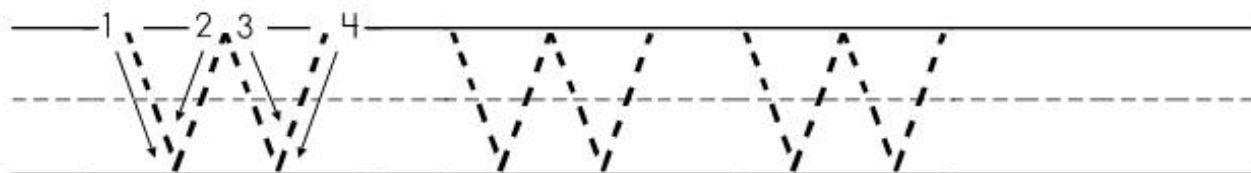
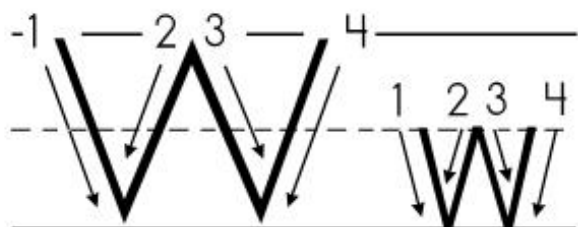

Name: _____

Write The Letter

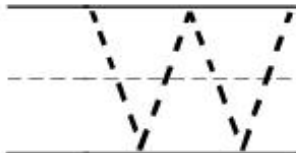
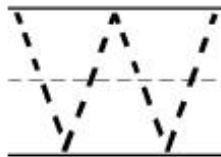
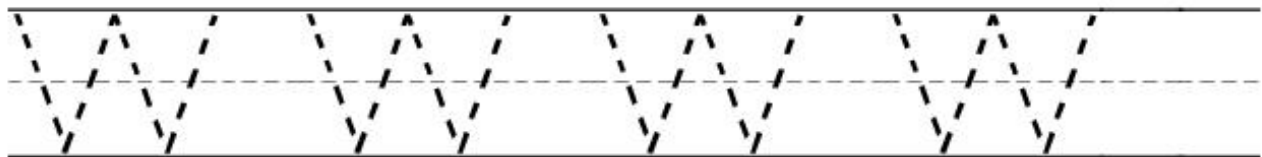
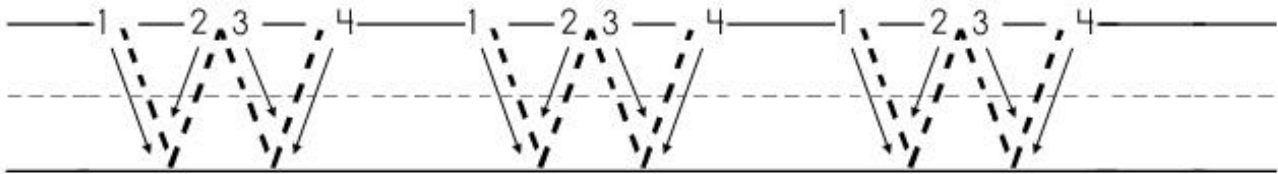
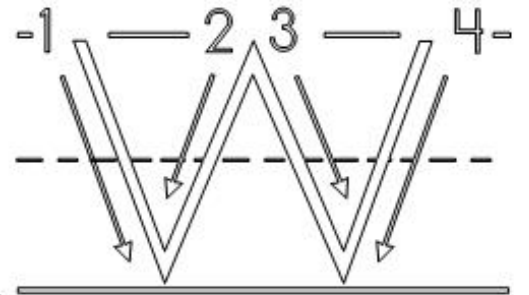
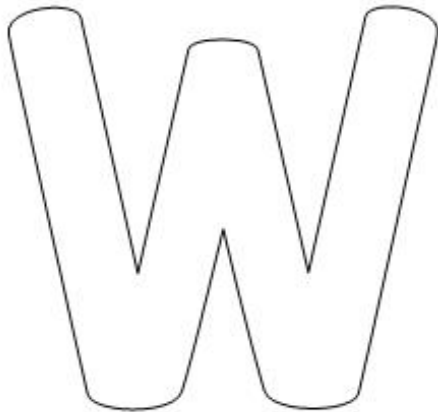

Name: _____

Find and Color

Color the pictures that begin with the letter W

Ww

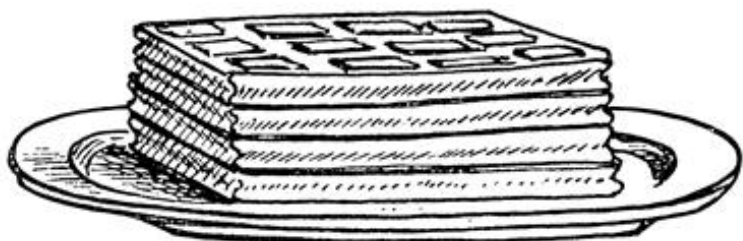

Name: -----

Letter Puzzles

Build the Upper and
Lower Case Puzzles

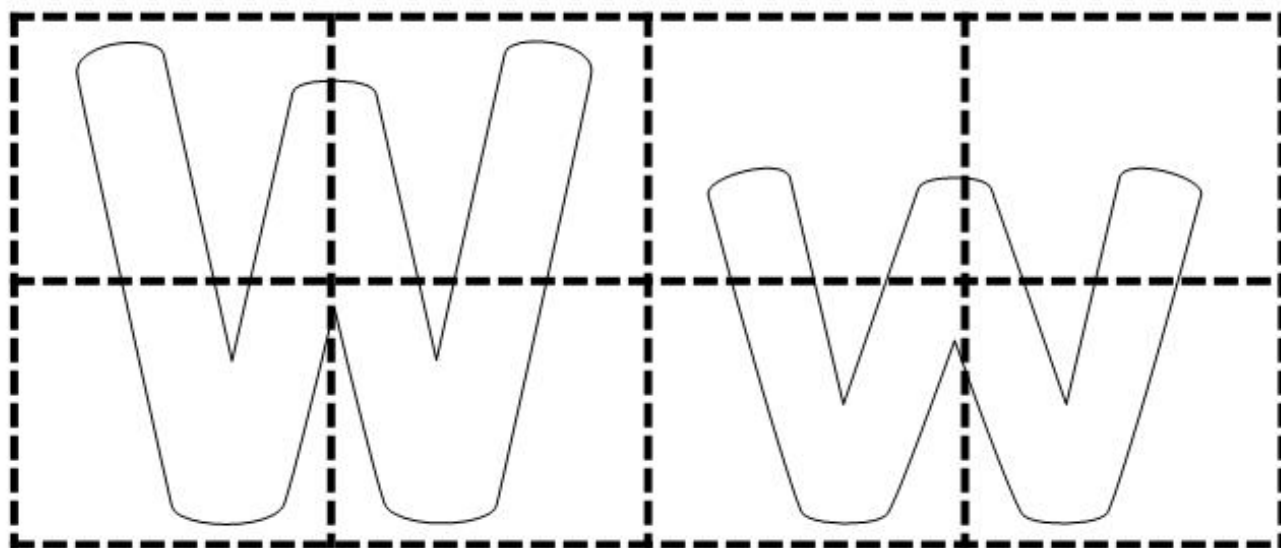

Name: _____

Letter Sorting

Sort the upper and lower case letters.

Ww

Upper

Lower

W

w

W

w

W

W

w

w

Name: _____

Graph The Letter

Count the letters and fill in the charts.

Ww

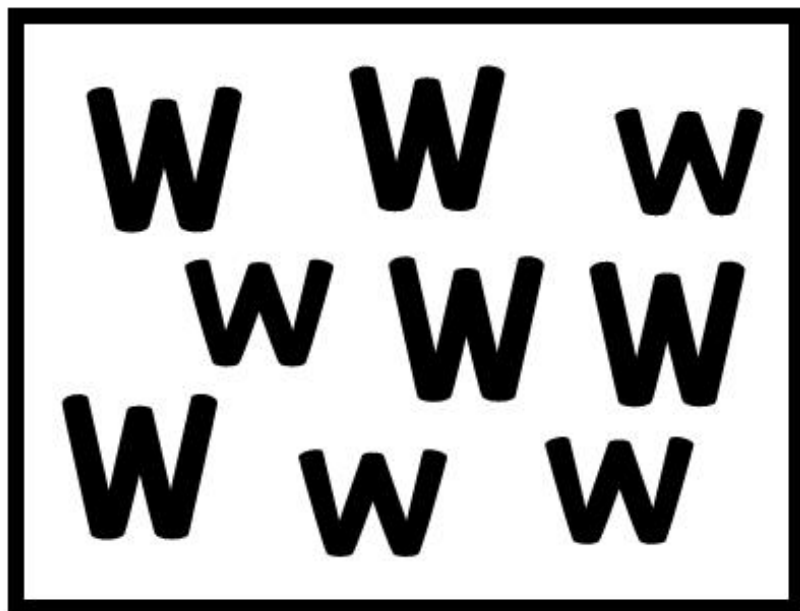

Tally Marks

W	

Color the letter there are more of.



1	2	3	4	5
1	2	3	4	5

Name: _____

Write The Letter

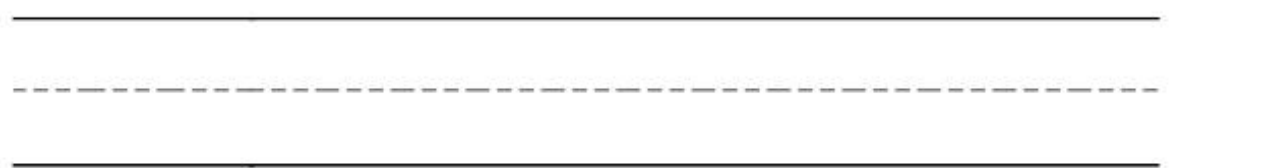
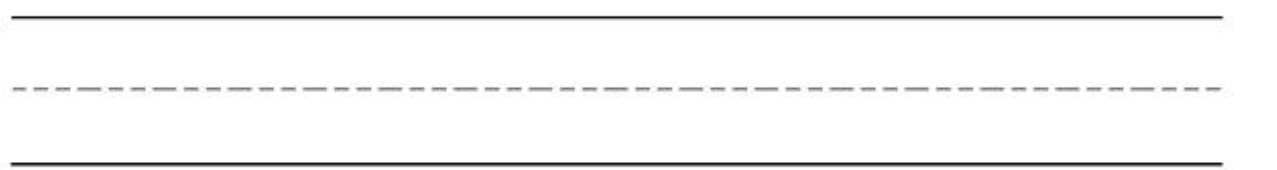
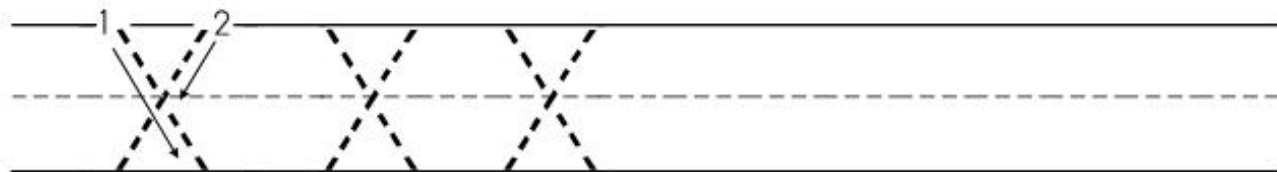
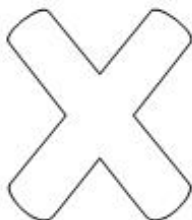
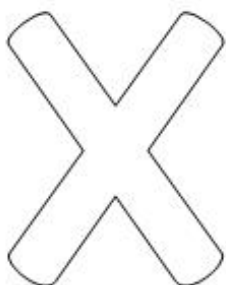
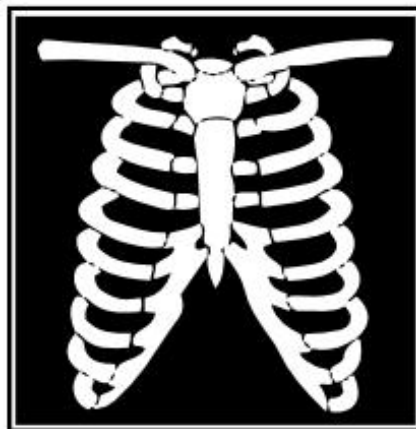
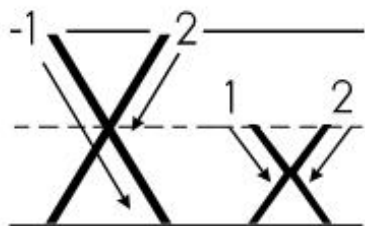

Name: _____

Write The Letter

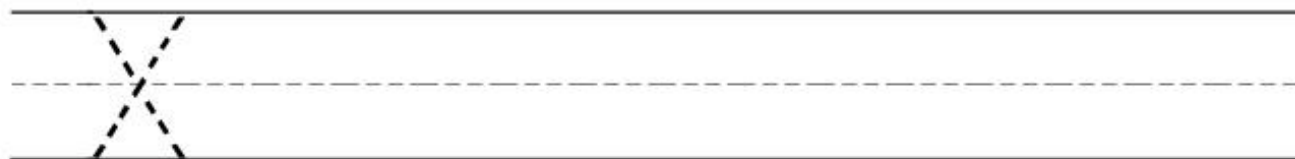
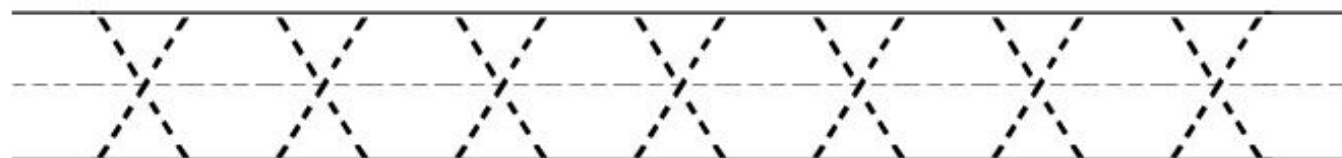
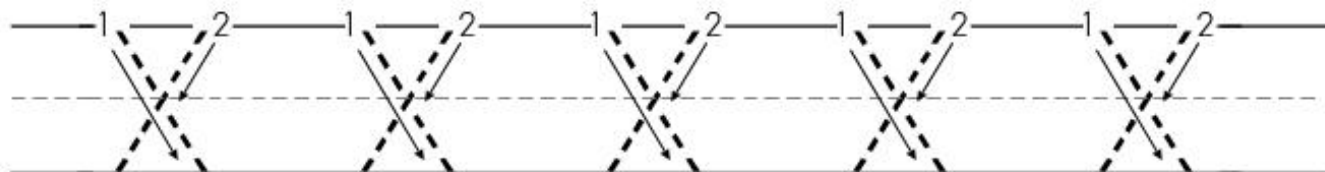
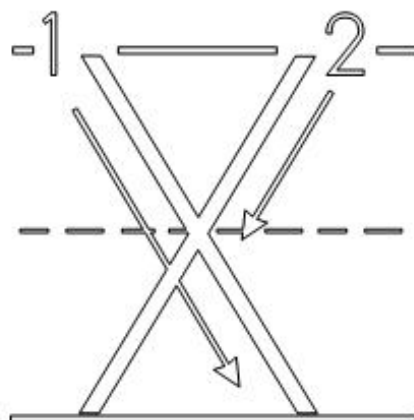
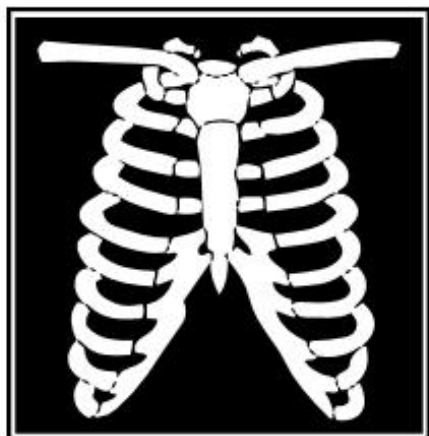
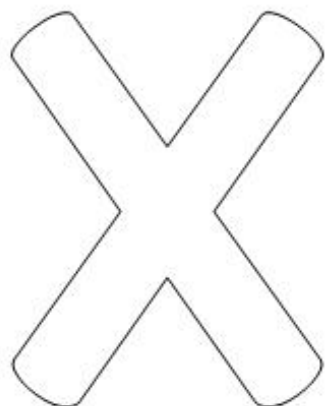

Name: _____

Find and Color

Color the pictures that begin with the letter X

Xx

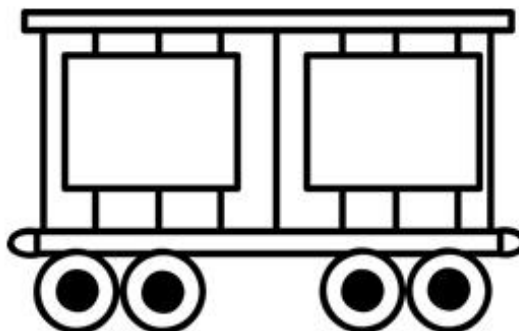
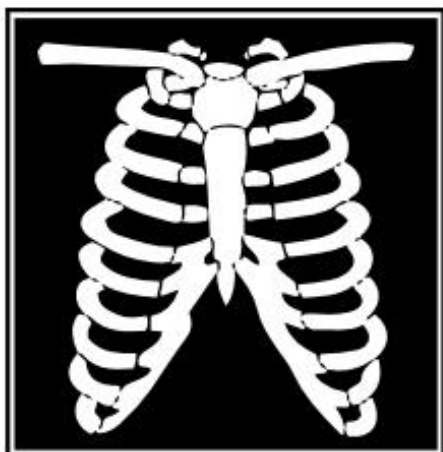
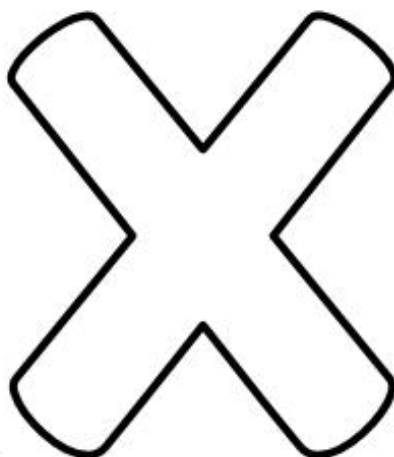
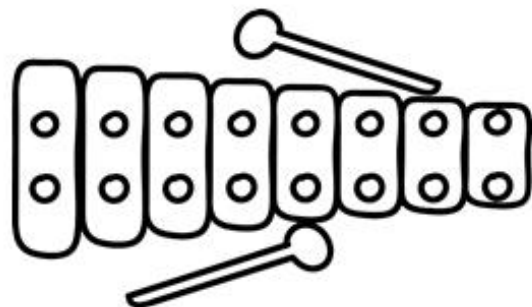

Name: -----

Letter Puzzles

Build the Upper and
Lower Case Puzzles

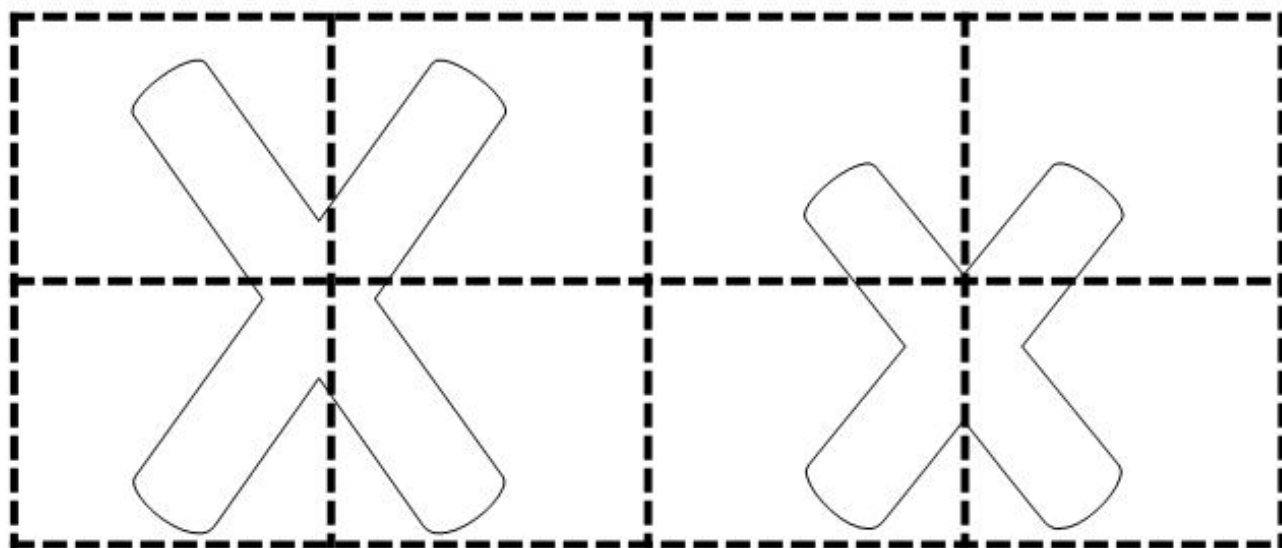

Name: _____

Letter Sorting

X x

Sort the upper and lower case letters.

Upper

Lower

X

x

X

x

X

X

x

x

Name: _____

Graph The Letter

Count the letters and fill in the charts.

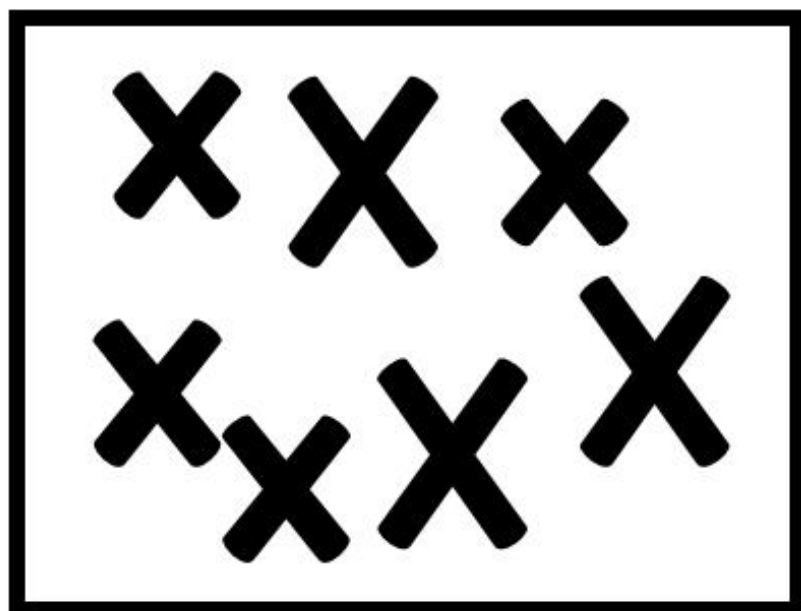

Tally Marks





Color the letter there are more of.

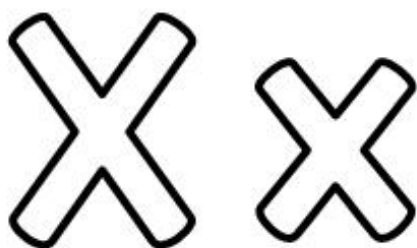

1	2	3	4	5
1	2	3	4	5

Name: _____

Write The Letter

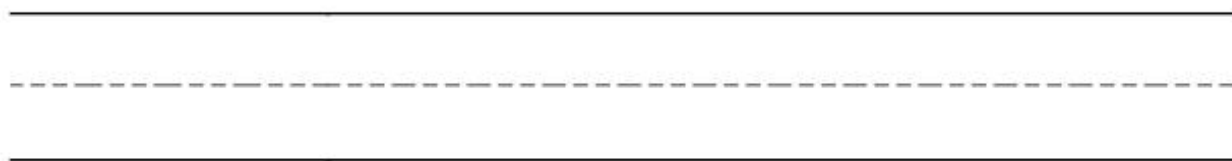
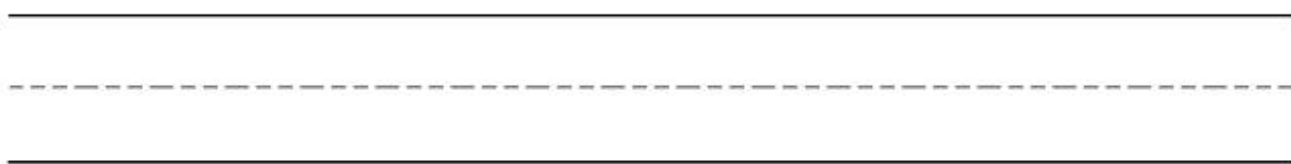
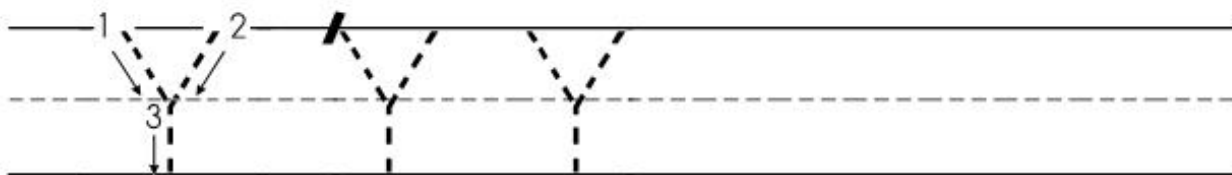
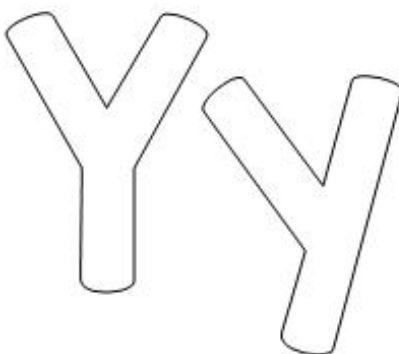
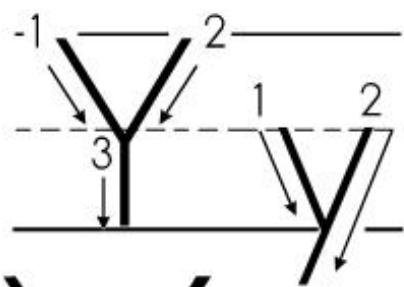

Name: _____

Write The Letter

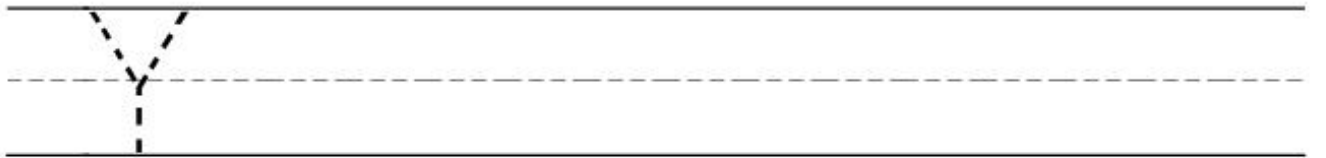
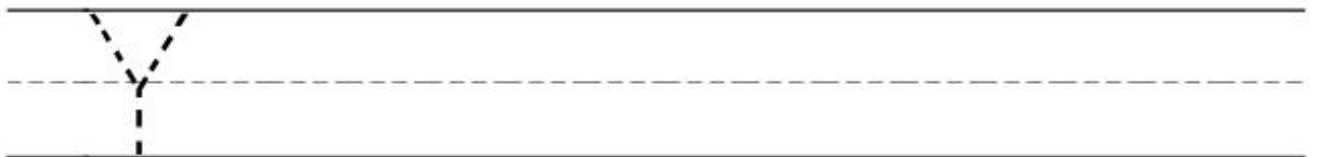
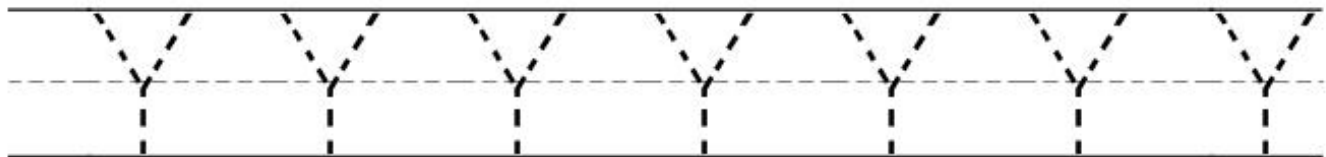
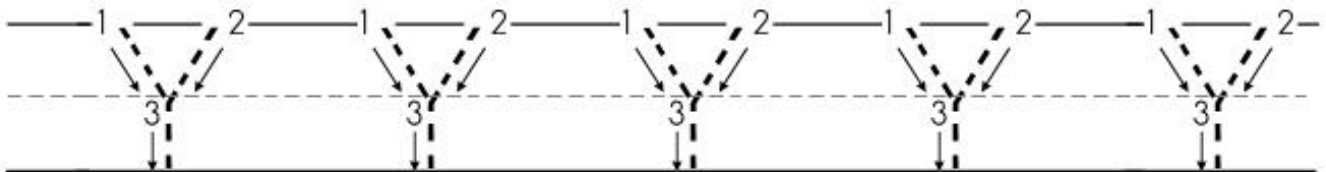
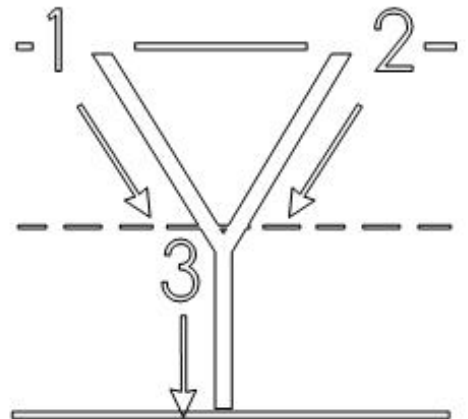
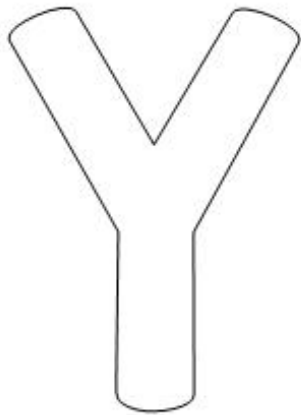

Name: _____

Find and Color

Color the pictures that begin with the letter Y

Yy

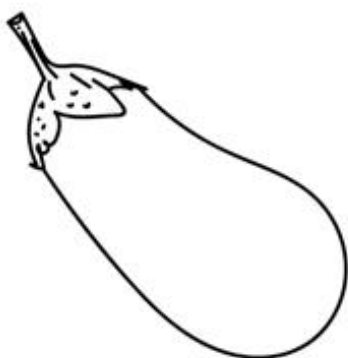

Name: -----

Letter Puzzles

Build the Upper and
Lower Case Puzzles

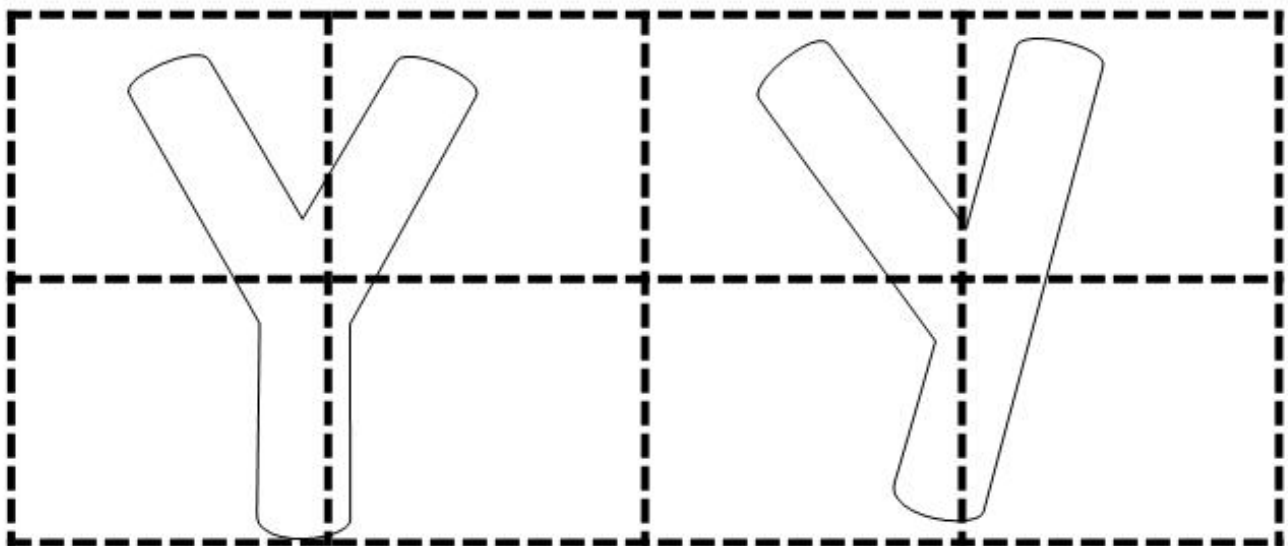

Name: _____

Letter Sorting

Yy

Sort the upper and lower case letters.

Upper

Lower

Y

y

y

y

Y

Y

y

y

Name: _____

Graph The Letter

Count the letters and fill in the charts.

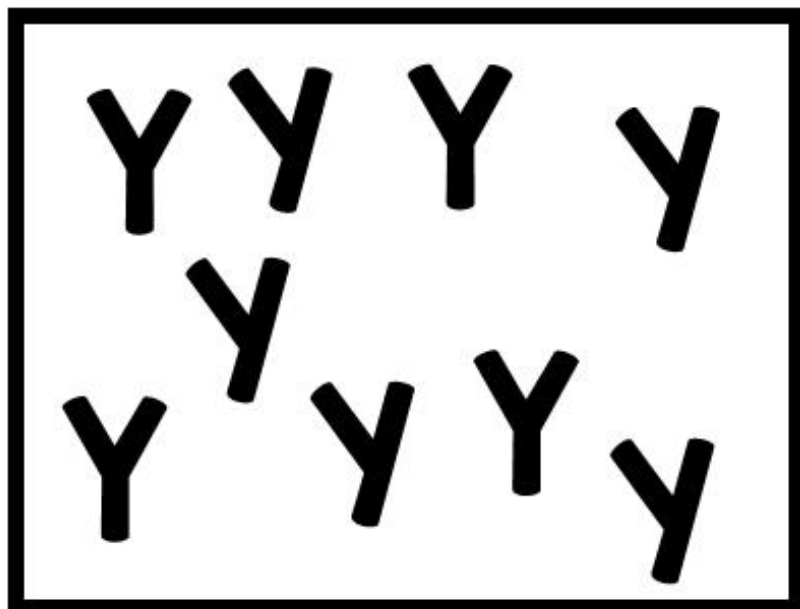

Tally Marks



Color the letter there are more of.



1	2	3	4	5
1	2	3	4	5

Name: _____

Write The Letter

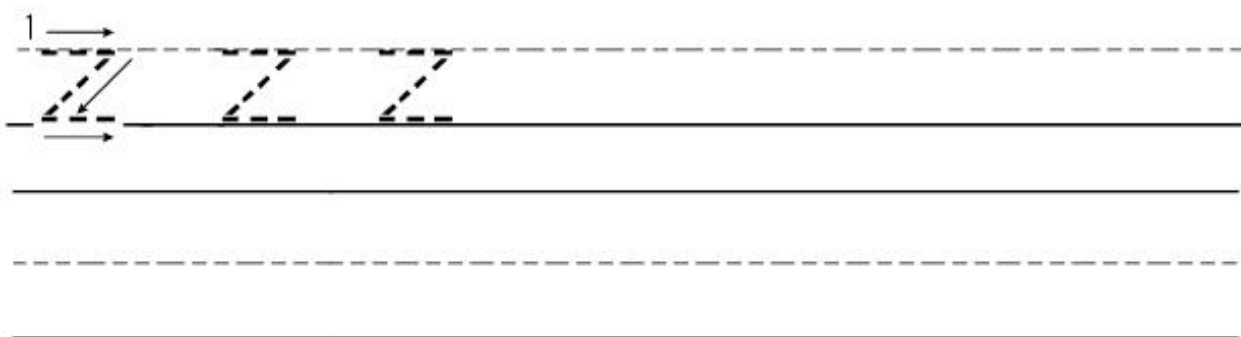
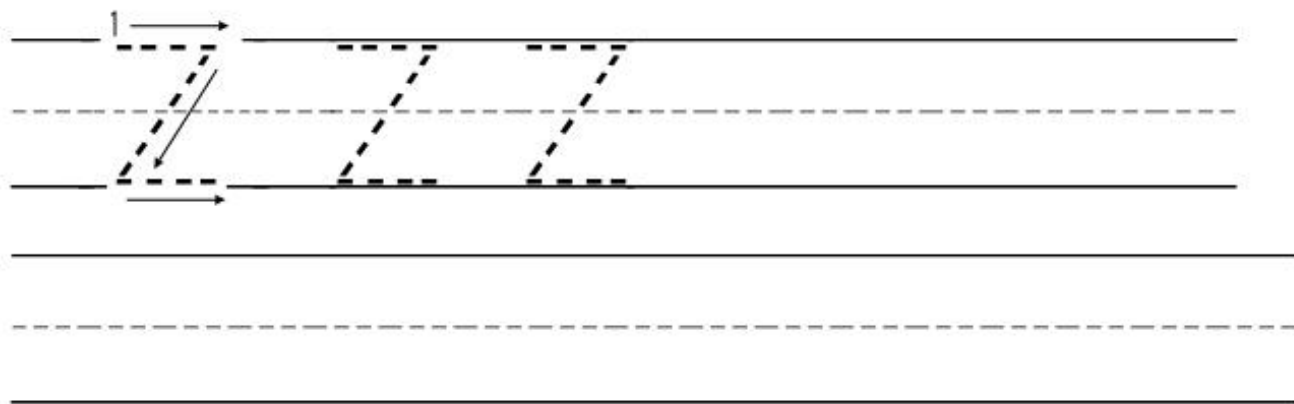
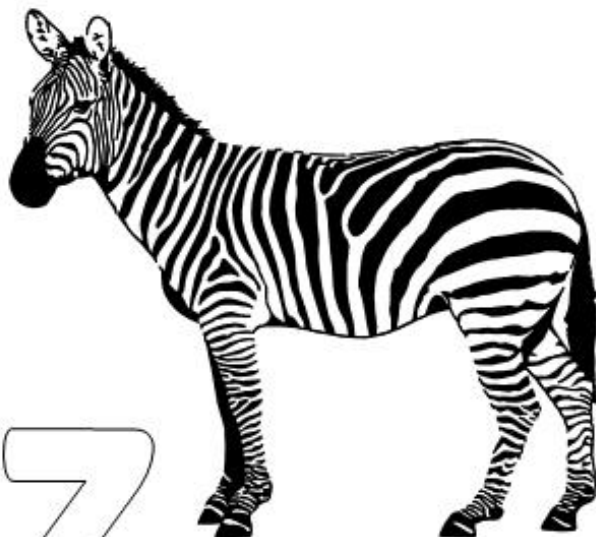
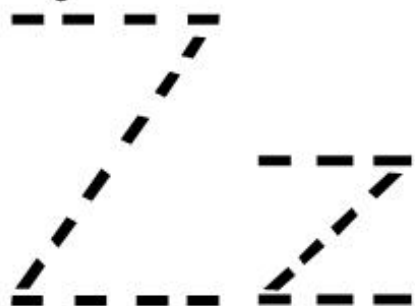
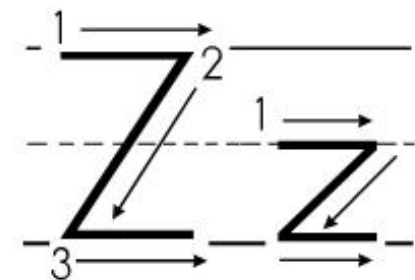

Name: _____

Write The Letter

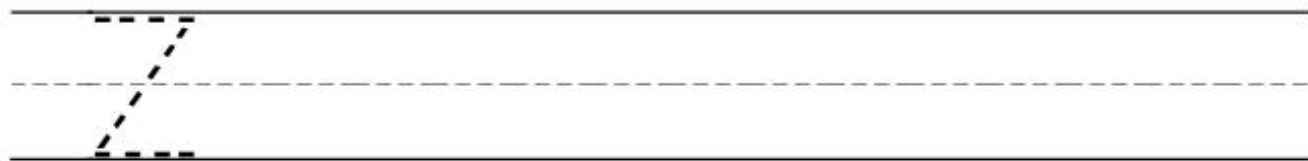
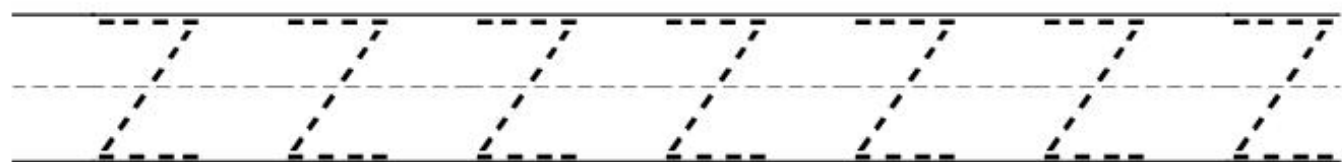
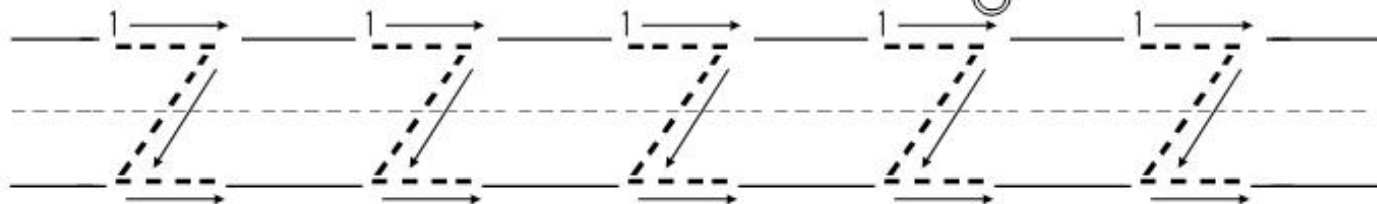
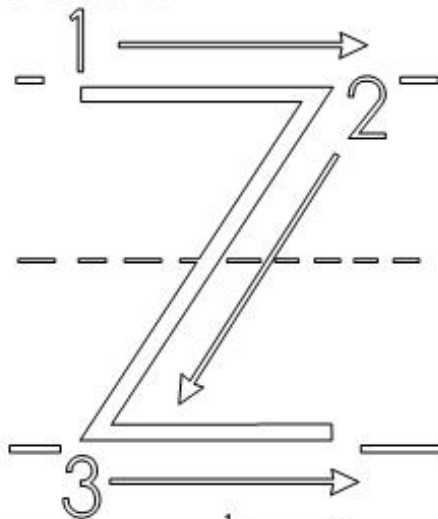

Name: _____

Find and Color

Color the pictures that begin with the letter Z

Zz

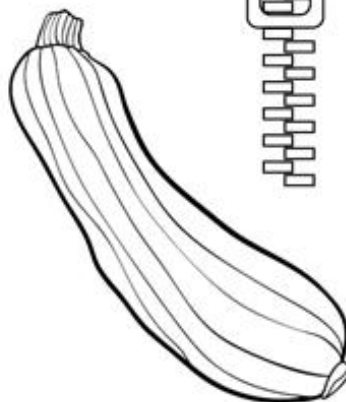
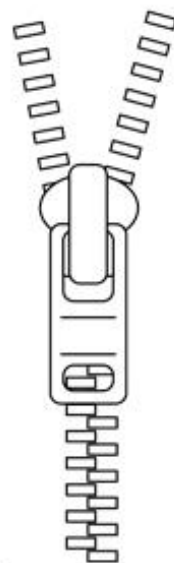
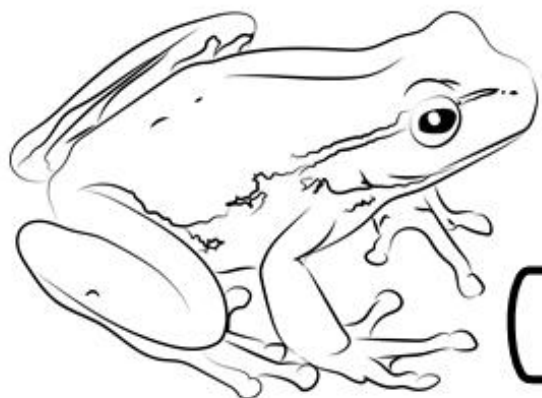

Name: -----

Letter Puzzles

Zz

Build the Upper and
Lower Case Puzzles

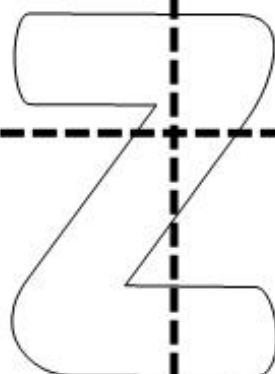
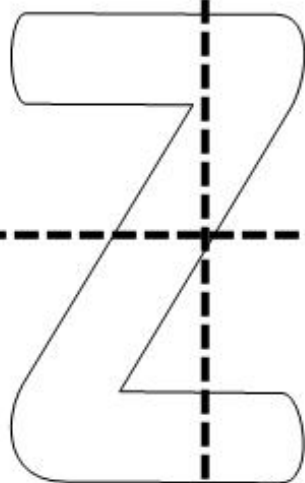

Name: _____

Letter Sorting

Zz

Sort the upper and lower case letters.

Upper

Lower

Z

z

Z

z

Z

Z

z

z

Name: _____

Graph The Letter

Count the letters and
fill in the charts.

Zz

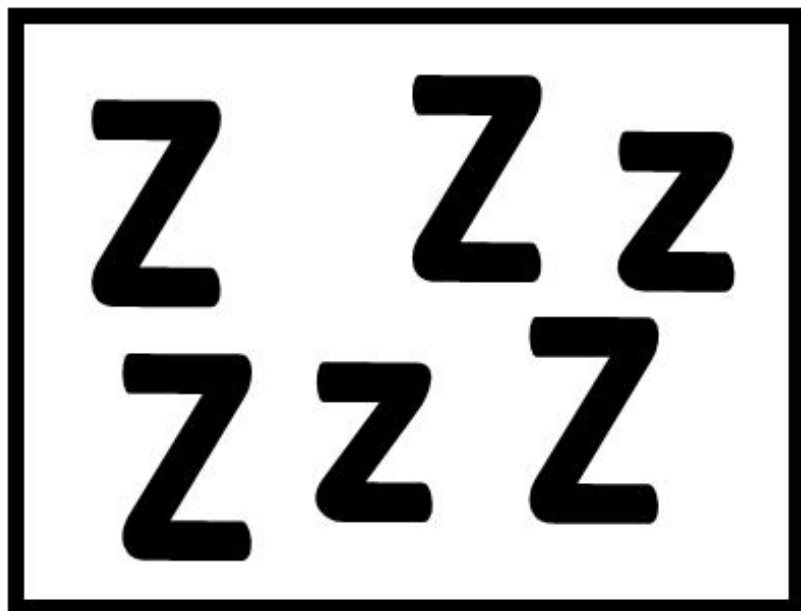

Tally Marks

Color the
letter there
are more of.



1	2	3	4	5
1	2	3	4	5